

OPERATING GUIDE for
SOLAR ARRAY SIMULATOR
AGILENT MODELS E4350B, E4351B

Agilent Model E4350B: US37410101 and Above *
Agilent Model E4351B: US37430101 and Above *

* For instruments with higher Serial Numbers, a change page may be included.



Agilent Technologies

Agilent Part No. 5962-8206
Microfiche 5962-8207

Printed in USA:
December, 1997

CERTIFICATION

Agilent Technologies Company certifies that this product met its published specifications at time of shipment from the factory. Agilent Technologies further certifies that its calibration measurements are traceable to the United States National Bureau of Standards, to the extent allowed by the Bureau's calibration facility, and to the calibration facilities of other International Standards Organization members.

WARRANTY

This Agilent Technologies hardware product is warranted against defects in material and workmanship for a period of three years from date of delivery. Agilent software and firmware products, which are designated by Agilent for use with a hardware product and when properly installed on that hardware product, are warranted not to fail to execute their programming instructions due to defects in material and workmanship for a period of 90 days from date of delivery. During the warranty period Agilent Technologies Company will, at its option, either repair or replace products which prove to be defective. Agilent does not warrant that the operation of the software, firmware, or hardware shall be uninterrupted or error free.

For warranty service, with the exception of warranty options, this product must be returned to a service facility designated by Agilent. Customer shall prepay shipping charges by (and shall pay all duty and taxes) for products returned to Agilent for warranty service. Except for products returned to Customer from another country, Agilent shall pay for return of products to Customer.

Warranty services outside the country of initial purchase are included in Agilent's product price, only if Customer pays Agilent international prices (defined as destination local currency price, or U.S. or Geneva Export price).

If Agilent is unable, within a reasonable time to repair or replace any product to condition as warranted, the Customer shall be entitled to a refund of the purchase price upon return of the product to Agilent.

LIMITATION OF WARRANTY

The foregoing warranty shall not apply to defects resulting from improper or inadequate maintenance by the Customer, Customer-supplied software or interfacing, unauthorized modification or misuse, operation outside of the environmental specifications for the product, or improper site preparation and maintenance. **NO OTHER WARRANTY IS EXPRESSED OR IMPLIED. AGILENT SPECIFICALLY DISCLAIMS THE IMPLIED WARRANTIES OF MERCHANTABILITY AND FITNESS FOR A PARTICULAR PURPOSE.**

EXCLUSIVE REMEDIES

THE REMEDIES PROVIDED HEREIN ARE THE CUSTOMER'S SOLE AND EXCLUSIVE REMEDIES. AGILENT SHALL NOT BE LIABLE FOR ANY DIRECT, INDIRECT, SPECIAL, INCIDENTAL, OR CONSEQUENTIAL DAMAGES, WHETHER BASED ON CONTRACT, TORT, OR ANY OTHER LEGAL THEORY.

ASSISTANCE

The above statements apply only to the standard product warranty. Warranty options, extended support contracts, product maintenance agreements and customer assistance agreements are also available. Contact your nearest Agilent Technologies Sales and Service office for further information on Agilent's full line of Support Programs.

SAFETY SUMMARY

The following general safety precautions must be observed during all phases of operation, service, and repair of this instrument. Failure to comply with these precautions or with specific warnings elsewhere in this manual violates safety standards of design, manufacture, and intended use of the instrument. Agilent Technologies Company assumes no liability for the customer's failure to comply with these requirements.

BEFORE APPLYING POWER.

Verify that the product is set to match the available line voltage and the correct fuse is installed.

GROUND THE INSTRUMENT.

This product is a Safety Class 1 instrument (provided with a protective earth terminal). To minimize shock hazard, the instrument chassis and cabinet must be connected to an electrical ground. The instrument must be connected to the ac power supply mains through a three-conductor power cable, with the third wire firmly connected to an electrical ground (safety ground) at the power outlet. For instruments designed to be hard-wired to the ac power lines (supply mains), connect the protective earth terminal to a protective conductor before any other connection is made. Any interruption of the protective (grounding) conductor or disconnection of the protective earth terminal will cause a potential shock hazard that could result in personal injury. If the instrument is to be energized via an external autotransformer for voltage reduction, be certain that the autotransformer common terminal is connected to the neutral (earthed pole) of the ac power lines (supply mains).

FUSES.

Only fuses with the required rated current, voltage, and specified type (normal blow, time delay, etc.) should be used. Do not use repaired fuses or short circuited fuseholders. To do so could cause a shock or fire hazard.

DO NOT OPERATE IN AN EXPLOSIVE ATMOSPHERE.

Do not operate the instrument in the presence of flammable gases or fumes.

KEEP AWAY FROM LIVE CIRCUITS.

Operating personnel must not remove instrument covers. Component replacement and internal adjustments must be made by qualified service personnel. Do not replace components with power cable connected. Under certain conditions, dangerous voltages may exist even with the power cable removed. To avoid injuries, always disconnect power, discharge circuits and remove external voltage sources before touching components.

DO NOT SERVICE OR ADJUST ALONE.

Do not attempt internal service or adjustment unless another person, capable of rendering first aid and resuscitation, is present.

DO NOT EXCEED INPUT RATINGS.

This instrument may be equipped with a line filter to reduce electromagnetic interference and must be connected to a properly grounded receptacle to minimize electric shock hazard. Operation at line voltages or frequencies in excess of those stated on the data plate may cause leakage currents in excess of 5.0 mA peak.

SAFETY SYMBOLS.



Instruction manual symbol: the product will be marked with this symbol when it is necessary for the user to refer to the instruction manual (refer to Table of Contents) .



Indicates hazardous voltages.

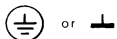

Indicate earth (ground) terminal.



The WARNING sign denotes a hazard. It calls attention to a procedure, practice, or the like, which, if not correctly performed or adhered to, could result in personal injury. Do not proceed beyond a WARNING sign until the indicated conditions are fully understood and met.



The CAUTION sign denotes a hazard. It calls attention to an operating procedure, or the like, which, if not correctly performed or adhered to, could result in damage to or destruction of part or all of the product. Do not proceed beyond a CAUTION sign until the indicated conditions are fully understood and met.

DO NOT SUBSTITUTE PARTS OR MODIFY INSTRUMENT.

Because of the danger of introducing additional hazards, do not install substitute parts or perform any unauthorized modification to the instrument. Return the instrument to an Agilent Technologies Sales and Service Office for service and repair to ensure that safety features are maintained.

Instruments which appear damaged or defective should be made inoperative and secured against unintended operation until they can be repaired by qualified service personnel.

SAFETY SUMMARY (continued)



















GENERAL

Any LEDs used in this product are Class 1 LEDs as per IEC 825-1.

ENVIRONMENTAL CONDITIONS

All instruments are intended for indoor use in an installation category II, pollution degree 2 environment. They are designed to operate at a maximum relative humidity of 95% and at altitudes of up to 2000 meters. Refer to the specifications tables for the ac mains voltage requirements and ambient operating temperature range.

SAFETY SYMBOL DEFINITIONS

Symbol	Description	Symbol	Description
	Direct current		Terminal for Line conductor on permanently installed equipment
	Alternating current		Caution, risk of electric shock
	Both direct and alternating current		Caution, hot surface
	Three-phase alternating current		Caution (refer to accompanying documents)
	Earth (ground) terminal		In position of a bi-stable push control
	Protective earth (ground) terminal		Out position of a bi-stable push control
	Frame or chassis terminal		On (supply)
	Terminal for Neutral conductor on permanently installed equipment		Off (supply)
	Terminal is at earth potential (Used for measurement and control circuits designed to be operated with one terminal at earth potential.)		Standby (supply) Units with this symbol are not completely disconnected from ac mains when this switch is off. To completely disconnect the unit from ac mains, either disconnect the power cord or have a qualified electrician install an external switch.

Herstellerbescheinigung

Diese Information steht im Zusammenhang mit den Anforderungen der Maschinenläminformationsverordnung vom 18 Januar 1991.

* Schalldruckpegel $L_p < 70$ dB(A) * Am Arbeitsplatz * Normaler Betrieb * Nach EN 27779 (Typprüfung).

Manufacturer's Declaration

This statement is provided to comply with the requirements of the German Sound Emission Directive, from 18 January 1991.

* Sound Pressure $L_p < 70$ dB(A) * At Operator Position * Normal Operation * According to EN 27779 (Type Test).

DECLARATION OF CONFORMITY

according to ISO/IEC Guide 22 and EN 45014

Manufacturer's Name: Agilent Technologies Company

Manufacturer's Address: 150 Green Pond Road
Rockaway, New Jersey 07866
U.S.A.

declares that the Product

Product Name: Solar Array Simulator

Model Number: Agilent E4350A, E4350B, E4351B

conforms to the following Product Specifications:

Safety: IEC 1010-1:1990+A1(1992) / EN 61010-1: 1993

EMC: CISPR 11:1990 / EN 55011:1991 - Group 1 Class A
IEC 801-2:1991 / EN 50082-1:1992 - 4 kV CD, 8 kV AD
IEC 801-3:1984 / EN 50082-1:1992 - 3 V / m
IEC 801-4:1988 / EN 50082-1:1992 - 0.5 kV Signal Lines
1 kV Power Lines

Supplementary Information:

The product herewith complies with the requirements of the Low Voltage Directive 73/23/EEC and the EMC Directive 89/336/EEC and carries the CE-marking accordingly.

New Jersey
Location

October 1997
Date



Bruce Krueger / Quality Manager

European Contact: Your local Agilent Technologies Sales and Service Office or Agilent Technologies GmbH,
Department TRE, Herrenberger Strasse 130, D-71034 Boeblingen (FAX:+49-7031-14-3143)

PRINTING HISTORY

The edition and current revision of this manual are indicated below. Reprints of this manual containing minor corrections and updates may have the same printing date. Revised editions are identified by a new printing date. A revised edition incorporates all new or corrected material since the previous printing date. Changes to the manual occurring between revisions are covered by change sheets shipped with the manual. In some cases, the manual change applies only to specific instruments. Instructions provided on the change sheet will indicate if a particular change applies only to certain instruments.

© Copyright 1997 Agilent Technologies Company

Edition 1 - December, 1997

This document contains proprietary information protected by copyright. All rights are reserved. No part of this document may be photocopied, reproduced, or translated into another language without the prior consent of Agilent Technologies Company. The information contained in this document is subject to change without notice.

Table Of Contents

1	General Information	
	What's In This Guide?	13
	Safety Considerations	13
	Options and Accessories.....	13
	Operator Replaceable Parts	14
	Description	14
	Key Features.....	14
	Output Characteristic.....	15
	Fixed Mode	15
	Simulator Mode.....	15
	Table Mode	17
2	Installation	
	Inspection	19
	Damage.....	19
	Packaging Material.....	19
	Items Supplied.....	19
	Location and Temperature.....	19
	Bench Operation.....	19
	Rack Mounting.....	20
	Temperature Performance	20
	AC Line Connection.....	20
	AC Voltage Conversion	21
	VXI plug&play Power Products Instrument Drivers.....	21
	Downloading and Installing the Driver	22
	Accessing Online Help.....	22
3	Turn-on Checkout	
	Introduction	23
	Preliminary Checkout	23
	Power-on Checkout	23
	Using the Keypad	24
	Shifted Keys	24
	Backspace Key	24
	Output Checkout.....	24
	Checking the Voltage Function	24
	Checking the Current Function.....	25
	Checking the Save and Recall Functions.....	27
	Determining GPIB Address.....	27
	In Case of Trouble.....	27
	Line Fuse	27
	Error Messages.....	27
	Selftest Errors.....	27
	Power-On Error Messages.....	27
	Checksum Errors	28
	Runtime Error Messages	28
4	User Connections	
	Rear Panel Connections.....	29
	Wire Selection	29
	Analog Connector.....	29
	Digital Connector	30
	Load Connections.....	30
	Output Isolation.....	30

Capacitive Loads	30
Inductive Loads	31
Connecting to an External Voltage Source.....	31
Sense Connections.....	31
Remote Voltage Sensing	31
CV Regulation.....	32
Overvoltage Protection Considerations	32
Output Rating	32
Output Noise	32
Stability	32
Over Current Protection Considerations.....	33
Hardware Overcurrent Circuit	33
Operating Configurations	33
Connecting the Load to One Unit	33
Connecting Supplies in Parallel.....	34
Connecting Supplies in Auto-Parallel.....	35
Auto-Parallel Programming Cautions.....	36
Connecting Supplies in Series	37
Analog Current Control.....	38
Controller Connections.....	38
Stand-Alone Connections	38
Linked Connections.....	38

5 Front Panel Operation

Introduction	41
Key Functions.....	41
Programming the Output	44
Establishing Initial Conditions.	44
Programming Voltage	44
Programming Current.....	45
Programming Overvoltage Protection	45
Setting the OVP Level.....	45
Checking OVP Operation.....	45
Clearing the OVP Condition	46
Programming Overcurrent Protection.....	46
Setting the OCP Protection.....	46
Checking OCP Operation.....	46
Clearing the OCP Condition.....	46
CV Mode vs. CC Mode.....	47
Unregulated Operation	47
Saving and Recalling States	47
Turn-on Conditions	47
Setting the GPIB Address.....	48
Types of GPIB Addresses	48
Changing the GPIB Address.....	48

6. Remote Programming

GPIB Capabilities of the Power Supply	49
Introduction to SCPI.....	49
Conventions.....	49
Types of SCPI Commands	50
Multiple Commands in a Message.....	50
Moving Among Subsystems.....	51
Value Coupling.....	51
Including Common Commands	51
SCPI Queries	51

Types of SCPI Messages	51
The Message Unit.....	52
Headers.....	52
Query Indicator	52
Message Unit Separator.....	52
Root Specifier.....	52
Message Terminator	52
SCPI Data Formats.....	53
Numerical Data.....	53
Suffixes and Multipliers	53
Character Data.....	53
Examples	54
Programming Voltage and Current.....	54
Programming Protection Circuits	54
Programming Units in Auto-Parallel	54
Changing Outputs by Trigger	55
Saving and Recalling States	55
Writing to the Display	56
Programming Status	56
Programming the Digital I/O Port	56
System Considerations	56
Assigning GPIB Address in Programs.....	57
Agilent 82335A Driver Considerations	57
National Instruments GPIB Driver Considerations	57
BASIC Considerations	57

7. Language Dictionary

Introduction.....	61
Parameters	61
Related Commands.....	61
Order of Presentation	61
Common Commands	61
Subsystem Commands.....	61
Description of Common Commands	62
*CLS.....	62
*ESE.....	62
*ESR?.....	63
*IDN?.....	63
*OPC.....	64
*OPC?	64
*OPT?	64
*PSC.....	65
*RCL.....	65
*RST	66
*SAV	66
*SRE	67
*STB?.....	67
*TRG.....	68
*TST?.....	68
*WAI.....	68
Description of Subsystem Commands	69
Calibration Commands	71
Display Subsystem	71
DISP	71
DISP:MODE	71
DISP:TEXT.....	72

Measure Subsystem.....	72
MEAS:CURRE?	72
MEAS:VOLT?	72
Memory Subsystem.....	73
MEM:COPY:TABL.....	73
MEM:DEL:ALL.....	73
MEM:DEL[:NAME].....	73
MEM:TABL:SEL.....	73
MEM:TABL:CURRE.....	73
MEM:TABL:VOLT.....	73
MEM:TABL:CURRE:POIN?.....	74
MEM:TABL:VOLT:POIN?.....	74
MEM:TABL:CAT?.....	74
Output Subsystem.....	74
OUTP.....	74
OUTP:PROT:CLE.....	74
OUTP:PROT:DEL.....	75
[SOUR:]CURRE.....	75
[SOUR:]CURRE:TRIG.....	75
[SOUR:]CURRE:MODE.....	76
[SOUR:]CURRE:PROT.....	76
[SOUR:]CURRE:PROT:STAT.....	76
[SOUR:]CURRE:SAS:ISC.....	77
[SOUR:]CURRE:SAS:IMP.....	77
[SOUR:]CURRE:TABL:NAME.....	77
[SOUR:]CURRE:TABL:OFFS.....	77
[SOUR:]DIG:DATA.....	77
[SOUR:]VOLT.....	78
[SOUR:]VOLT:TRIG.....	78
[SOUR:]VOLT:PROT.....	79
[SOUR:]VOLT:SAS:VOC.....	79
[SOUR:]VOLT:SAS:VMP.....	79
[SOUR:]VOLT:TABL:OFFS.....	80
Status Subsystem.....	80
STAT:OPER?.....	80
STAT:OPER:COND?.....	80
STAT:OPER:ENAB.....	81
STAT:OPER:PTR/NTR.....	81
STAT:PRES.....	81
STAT:QUES?.....	82
STAT:QUES:COND?.....	82
STAT:QUES:ENAB.....	82
STAT:QUES:PTR/NTR.....	83
System Commands.....	83
SYST:ERR?.....	83
SYST:VERS?.....	84
Trigger Subsystem.....	84
ABOR.....	84
INIT84.....	
INIT:CONT.....	84
TRIG.....	85
TRIG:SOUR.....	85

8.	Status Reporting	
	Agilent SAS Status Structure.....	87
	Operation Status Group.....	87
	Register Functions.....	87
	Register Commands.....	87
	Questionable Status Group.....	89
	Register Functions.....	89
	Register Commands.....	89
	Standard Event Status Group.....	89
	Register Functions.....	89
	Register Commands.....	89
	Status Byte Register.....	89
	The RQS Bit.....	90
	The MSS Bit.....	90
	Determining the Cause of a Service Interrupt.....	90
	Service Request Enable Register.....	90
	Output Queue.....	90
	Initial Conditions at Power-On.....	90
	Status Registers.....	90
	The PON (Power-On) Bit.....	91
	Examples.....	91
	Servicing an Operation Status Mode Event.....	91
	Adding More Operation Events.....	91
	Servicing Questionable Status Events.....	91
	Monitoring Both Phases of a Status Transition.....	92
	SCPI Command Completion.....	92
	DFI (Discrete Fault Indicator).....	92
	RI (Remote Inhibit).....	93
	Using Device Clear.....	93
A	Specifications and Application Information	
	Specifications and Supplemental Characteristics.....	95
	Output Impedance Graphs.....	99
	Simulator Mode.....	99
	Fixed Mode.....	101
	Peak Power Tracker Application.....	102
	Exponential Model Equations.....	103
	Series Switching Regulation.....	104
	Shunt Switching Regulation.....	104
B	Verification and Calibration	
	Introduction.....	105
	Test Equipment Required.....	105
	Current Monitoring Resistor.....	105
	Verification.....	106
	General Measurement Techniques.....	106
	Programming the Agilent SAS.....	106
	Order of Tests.....	106
	Turn On Checkout.....	106
	Voltage Programming and Readback Accuracy.....	106
	Current Programming and Readback Accuracy.....	107
	Calibration.....	108
	Test Equipment Required.....	108
	General Procedure.....	108
	Parameters Calibrated.....	108
	Front Panel Calibration.....	109

Entering the Calibration Values	109
Saving the Calibration Constants.....	109
Disabling the Calibration Mode	109
Changing the Calibration Password.....	109
Recovering From Calibration Problems	111
Calibration Error Messages	111
Calibration over the GPIB	111
Calibration Example.....	111
Calibration Language Dictionary	112
CAL:CURR	112
CAL:CURR:LEV	112
CAL:PASS	112
CAL:SAVE	112
CAL:STAT.....	113
CAL:VOLT	113
CAL:VOLT:LEV	113
CAL:VOLT:PROT	113
Agilent Basic Calibration Program.....	114
C	
Digital Port Functions	
Digital Connector	117
Fault/Inhibit Operation	117
Changing the Port Configuration.....	119
Digital I/O Operation.....	119
D	
Error Messages	
Hardware Error Messages	121
Calibration Error Messages	121
System Error Messages	121
Index	123
Agilent Sales and Support Offices	128

General Information

What's In This Guide?

This guide describes the Agilent Model E4350B/E4351B Solar Array Simulator (SAS). An overview of the unit is given in this chapter. Installation and user connections are discussed in chapters 2 and 4. Programming from the front panel and over the GPIB is discussed in chapters 5-7. If you just need to check that the unit is operating properly, read chapter 3.

The edition and current revision of this manual are indicated on the title page. Reprints of this manual containing minor corrections and updates may have the same printing date. Revised editions are identified by a new printing date. A revised edition incorporates all new or corrected material since the previous printing date.

Changes to the manual occurring between revisions are covered by change sheets shipped with the manual. In some cases, the manual change applies only to specific instruments. Instructions provided on the change sheet will indicate if a particular change applies only to certain instruments.

Safety Considerations

The Agilent Solar Array Simulator is a Safety Class 1 instrument, which means it has a protective earth terminal. That terminal must be connected to earth ground through a power source equipped with a 3-wire ground receptacle. Refer to the Safety Summary page at the beginning of this guide for general safety information. Before installation or operation, check the Agilent SAS and review this guide for safety warnings and instructions. Safety warnings for specific procedures are located at appropriate places in the guide.

Options and Accessories

Table 1-1 Options

Option	Description
100	Input power 100 Vac, nominal
220	Input power 220 Vac, nominal
240	Input power 240 Vac, nominal (for 230 Vac operation, see table A-2 in appendix A)
	Rack mount kit (Agilent 5062-3977) Support rails (E3663A) are required.
	Rack mount kit (Agilent 5062-3977 & 5062-3974) Support rails (E3663A) are required.
909	Rack mount kit with handles (Agilent 5062-3983) Support rails (E3663A) are required.
910	Service manual with extra User's guides

Table 1-2 Accessories

Accessory Description	Agilent No.
GPIB cable (all models)	
0.5 meters (1.6 ft)	10833D
1.0 meter (3.3 ft)	10833A
2.0 meters (6.6 ft)	10833B
4.0 meters (13 .2 ft)	10833C
Serial link cable (all models)	
2.0 meters (6.6 ft)	5080-2148
Slide mount kit	1494-0059

Operator Replaceable Parts

Table 1-3 Operator Replaceable Parts

Description	Agilent Part No.	Description	Agilent Part No.
Cover, dc output	0360-2191	Plug, analog connector	1252-3698
Foot, cabinet	5041-8801	Plug, digital connector	1252-1488
Fuse, power		Screw, output bus bar	0515-1085
100 Vac line voltage, 15 A	2110-0054	Screw, terminal cover	0515-1085
120 Vac line voltage, 12 A	2110-0249	Screw, carrying strap, M5x0.8x10 mm	0515-1132
220/230/240 Vac line voltage, 7 A	2110-0614	Standoff, GPIB	0380-0644
Knob, rotary output control	0370-3238		

Description

The Agilent E4350B/E4351B Solar Array Simulator (SAS) is a dc power source that simulates the output characteristics of a solar array. The Agilent SAS is primarily a current source with very low output capacitance. It is capable of simulating the I-V curve of a solar array under different conditions such as temperature and age. The I-V curve is programmable over the IEEE-488.2 bus and is automatically generated within the Agilent SAS. The Agilent SAS has three operating modes:

Fixed Mode: This is the default mode that occurs when the unit is first powered up. The I-V output has the rectangular characteristics of a standard power supply, but with excellent high speed constant current characteristics and low output capacitance. Fixed mode allows front panel programming and is convenient when, in certain applications, the I-V curve is not needed.

Simulator Mode: An internal algorithm is used to simulate a SAS I-V curve. One can easily approximate the curve through four input parameters: open circuit voltage (Voc), short circuit current (Isc), current at the approximate maximum power point on the curve (Imp), and voltage at the approximate maximum power point on the curve (Vmp).

Table Mode: The Agilent SAS provides a table mode for a fast and accurate I-V simulation of solar arrays. In this mode, a table of I-V points, often provided by the solar array manufacturer, specifies the curve. The Agilent SAS provides up to 60 tables with a total of 33,500 I-V points of storage and a maximum of 4,000 I-V points per table. The tables (I-V curves) are easily stored and recalled. A portion of table storage is allocated in non-volatile memory, with 30 possible tables totaling 3,500 points. These are retained when power is turned off. In table mode, current and voltage offsets can be applied to the selected table to simulate a change in the operating conditions of the solar array.

Key Features

- 480 Watt output
- Auto-parallel capability for higher power
- Very low output capacitance
- Switching recovery time in less than 5 microseconds
- Programmable overvoltage and over-current protection which are independent of other circuits
- Overtemperature protection
- Fan speed control to minimize acoustic noise
- Extensive set of programming features
- Fast I-V curve change in both table and simulator modes
- Up to 60 volatile/non-volatile tables
- Self test at power-up or from an IEEE-488.2 command
- Serial link to connect up to 16 outputs to one IEEE-488.2 address
- Standard Commands for Programmable Instruments (SCPI)

Output Characteristic

The Agilent E4350B/E4351B Solar Array Simulator can be operated in three modes: fixed mode, simulator mode, and table mode. Mode switching on the Agilent SAS is accomplished over the GPIB bus via the SCPI CURRent:MODE command.

You cannot switch modes from the front panel.

Note: The Agilent SAS must be connected to a computer for you to be able to use the SAS functions that are available in simulator and table modes.

The front panel does not indicate which mode the Agilent SAS is presently operating in. If you are unsure which mode the unit is presently in, you can query the unit over the GPIB using the CURRent:MODE? command. If you cycle power to the unit, it will be in Fixed mode.

Fixed Mode

At power turn on, with *RST, or when executing a Device Clear, the operating state of the Agilent SAS is Fixed mode (see Figure 1-1). In Fixed mode, the output characteristic is similar to that of a standard power supply, except that the output capacitance is <100 nF on the Agilent E4350B, and <50 nF on the Agilent E4351B. This low output capacitance is ideal when using the unit as a constant current source. To use the unit as a low-impedance constant voltage source however, you can add an external output capacitor if so desired. The value of the external capacitor should not exceed 2,000 μ F.

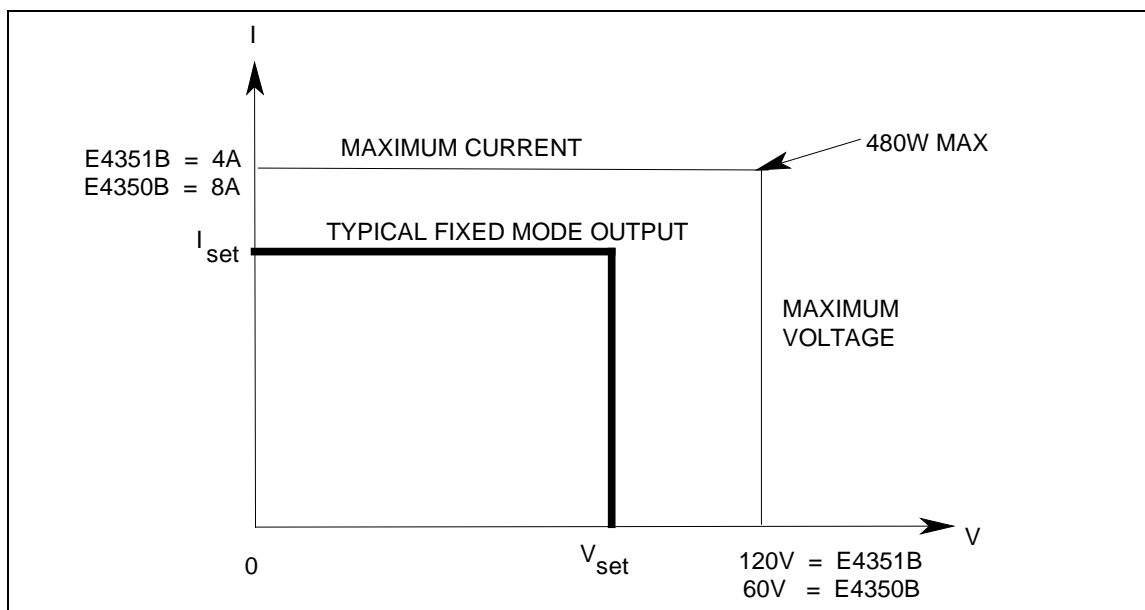

Figure 1-1. Fixed Mode Characteristic

Restrictions

- If the programmed values exceed the maximum current and voltage boundaries by more than 2 or 3 percent, an OUT OF RANGE error will be indicated.

Simulator Mode

Simulator mode uses an exponential model to approximate the I-V curve (see Figure 1-2). It is programmed in terms of its open circuit voltage (V_{oc}), short circuit current (I_{sc}), voltage point (V_{mp}), and current point (I_{mp}) at approximately the peak power point (see page A-9 in appendix A for model equations). Simulator mode operation is achieved by sampling the output voltage, applying a low-pass filter, and continually adjusting the constant current loop by using the filtered voltage as an index into the exponential model.

Front panel operation:

You can use the front panel when the unit is operating in Simulator mode. To do this, press the **Local** key whenever the front panel **RMT** annunciator is on. Be aware however, that any voltage and current values that you enter from the front panel will have no effect on the unit while it is in Simulator mode. These front panel values will take effect as soon as the unit is placed in Fixed mode. Likewise, the OCP function only takes effect in Fixed mode. All other functions such as Local, Error, Output On/Off, Protect are active while the unit is operating in Simulator mode.

Table Mode

In Table mode, the output characteristic is determined by a user-defined table of voltage/current points (see Figure 1-3). Table mode operation is achieved by sampling the output voltage, applying a low-pass filter, and continually adjusting the constant current loop by using the filtered voltage as an index into the stored table of points. Linear interpolation is used to set the current when the filtered voltage does not have an exactly matching table entry. What this means is that the I-V curve is generated by connecting the points in the table by straight lines. The more points that you provide, the more accurate the curve will be when the points are connected.

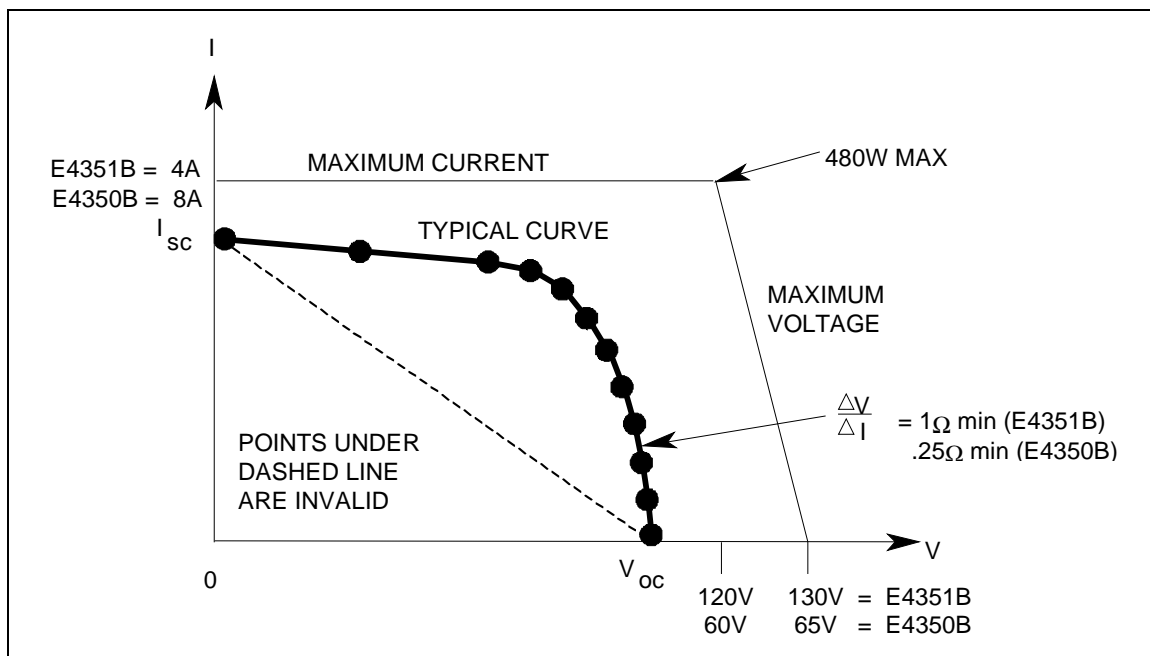

Figure 1-3. Table Mode Characteristic

Each table can have a maximum of 4,000 output points (3,500 points if it will be stored in non-volatile memory). Each output point is defined by a voltage/current coordinate pair of values that define the location of the point on the curve. The first value is the voltage, the second value is the current. If no point is supplied for $V=0$, the current associated with the lowest voltage entry point is defined as I_{sc} and the curve will be extended horizontally to the current axis. If no point is supplied for $I=0$, the slope that was determined by the last two current entry points will be extended to the voltage axis.

Multiple tables can be defined and saved in non-volatile memory (which is limited to 3500 points), or volatile memory (which is limited to 30,000 points). Up to 30 tables can be saved in each memory.

Restrictions

- The number of points in a table can vary from 3 to 4000, but an equal number of voltage and current values must be sent. Otherwise an error will occur when the table is selected with `CURRENT:TABLE:NAME`. Use `MEMORY:TABLE:CURRENT:POINTS?` and `MEMORY:TABLE:VOLTAGE:POINTS?` to find the length of an existing table.
- Points must be above dashed line shown in Figure 1-3.

- There is no restriction on the spacing between points in either voltage or current, but the points must be monotonic. Voltage values must be sent in increasing order of magnitude; current values must be sent in equal or decreasing order of magnitude. For an Agilent E4350B for example: (1,8) (50,7.8) (55,7.5) (56,7) (57, 6) (58, 4) (59,1).
- Each table point, when combined with the table offset, cannot exceed the unit's maximum voltage, current, or power.
- A table cannot be deleted or redefined while it is selected with CURRent:TABLE:NAME.
- Maximum Power ≤ 480 W
- $\Delta V/\Delta I \geq .25 \Omega$ for Agilent E4350B; $\geq 1 \Omega$ for Agilent E4351B
 $V_{oc} \leq 65V$ (Agilent E4350B); $130V$ (Agilent E4351B)
 $I_{sc} \leq 8A$ (Agilent E4350B); $4A$ (Agilent E4351B)
 The V_{mp} and I_{mp} points are calculated internally and need not be supplied.

NOTE: When the unit detects an invalid voltage/current point, it will generate an error, light the ERR annunciator on the front panel, and will not use the new parameters. Instead, it will operate with the last valid table settings. Therefore, although it may seem that the unit is operating correctly, it will **NOT** be using the values that you have programmed for table mode.

Table Offsets:

A new table can be generated by applying a limited voltage or current offset to an existing table. This can be helpful in simulating temperature, angular, rotational, or aging changes. Offset values are non-cumulative, they can be either positive or negative, and can be applied to any table. Each time a voltage or current offset is programmed, a new I-V curve is calculated based on the user-defined table that is presently active and the supplied offset values. Offset values affect the original I-V curve as follows:

- Positive Voltage Offsets:** The original curve is shifted to the right (\rightarrow) along the positive voltage axis, and the first point on the curve is extended horizontally at I_{sc} until it intersects the current axis. Thus, the new V_{oc} equals the original V_{oc} plus the offset value. An error will be generated if the offset causes the maximum allowed V_{oc} or the power limit to be exceeded.
- Negative Voltage Offsets:** The original curve is offset to the left (\leftarrow) along the positive voltage axis, and terminated at the current axis. The curve points that are not used because they extended beyond the current axis are not deleted; they will be valid once again if the negative voltage offset is reduced or eliminated.
- Positive Current Offsets:** The original curve is offset up (\uparrow) along the positive current axis, and the last point on the curve will be extended (at the same slope that was present in the original table curve at V_{oc}) until it intersects the voltage axis at a new, slightly higher V_{oc} value. The new I_{sc} equals the original I_{sc} plus the offset value. An error will be generated if the offset causes the maximum allowed I_{sc} , V_{oc} , or the power limit to be exceeded.
- Negative Current Offsets:** The original curve is offset down (\downarrow) along the positive current axis, and terminated at the voltage axis at a new, lower V_{oc} value. The curve points that are not used because they are extended beyond the voltage axis are not deleted; they will be valid once again if the negative current offset is reduced or eliminated.

Front panel operation:

You can use the front panel when the unit is operating in Table mode. To do this, press the **Local** key whenever the front panel **RMT** annunciator is on. Be aware however, that any voltage and current values that you enter from the front panel will have no effect on the unit while it is in Table mode. The front panel values will take effect as soon as the unit is placed in Fixed mode. Likewise, the OCP function only takes effect in Fixed mode. All other functions such as Local, Error, Output On/Off, Protect are active while the unit is operating in Simulator mode.

Installation

Inspection

Damage

When you receive your Agilent SAS, inspect it for any obvious damage that may have occurred during shipment. If there is damage, notify the shipping carrier and the nearest Agilent Sales and Support Office immediately. Warranty information is printed in the front of this guide.

Packaging Material

Until you have checked out the Agilent SAS, save the shipping carton and packing materials in case the Agilent SAS has to be returned to Agilent Technologies . If you return the Agilent SAS for service, attach a tag identifying the model number and the owner. Also include a brief description of the problem.

Items Supplied

In addition to this manual, check that the following items in Table 2-1 are included with your Agilent SAS

Table 2-1. Items Supplied

Power cord	Your Agilent SAS was shipped with a power cord for the type of outlet specified for your location. If the appropriate cord was not included, contact your nearest Agilent Sales and Support Office (see end of this guide) to obtain the correct cord. Caution: The Agilent SAS cannot use a standard power cord. The power cords supplied by Agilent Technologies have heavier gauge wire.
Analog connector	A 7-terminal analog plug (see table 1-3 in chapter 1) that connects to the back of the unit. Analog connections are described in chapter 4.
Digital connector	A 4-terminal digital plug (see table 1-3 in chapter 1) that connects to the back of the unit. Digital connections are described in appendix C - Digital Port Functions
Serial cable	A 2-meter cable (see table 1-2 in chapter 1) that connects to the control bus (next to the GPIB connector). This cable is used to serially connect multiple supplies as described under Controller Connections in Chapter 4.
Change page	If applicable, change sheets may be included with this guide. If there are change sheets, make the indicated corrections in this guide.

Location and Temperature

Bench Operation

The Supplemental Characteristics in appendix A give the dimensions of your Agilent SAS. The cabinet has plastic feet that are shaped to ensure self-alignment when stacked with other Agilent System II cabinets. The feet may be removed for rack mounting. Your Agilent SAS must be installed in a location that allows sufficient space at the sides and rear of the cabinet for adequate air circulation. Minimum clearances are 1 inch (25 mm) along the sides. Do not block the fan exhaust at the rear of the unit.

Rack Mounting

The Agilent SAS can be mounted in a standard 19-inch rack panel or cabinet. Rack mounting kits are available as Option 908 or 909 (with handles). Installation instructions are included with each rack mounting kit.

Support rails are required when rack-mounting the Agilent SAS (see table 1-1).

Temperature Performance

A variable-speed fan cools the unit by drawing air through the sides and exhausting it out the back. Using Agilent rack mount or slides will not impede the flow of air. The Agilent SAS operates without loss of performance within the temperature range of 0 °C to 40 °C and with derated output current from 40 °C to 55 °C (see appendix A).

WARNING

If the Agilent SAS is operated at full output current for several hours, the sheet metal immediately under the transformer (near the right front) can get very hot. Do not touch this area of the cabinet. The line cord also can become quite warm. Both of these conditions are normal.

AC Line Connection

Refer to the applicable paragraphs below for information on the ac line. *Do not apply power to the Agilent SAS until directed to do so in Chapter 3.*

CAUTION

Check the line **Rating** label on the rear of your unit and verify that the voltage shown there corresponds to the nominal line voltage of your ac line. If it does not, see AC Line Voltage Conversion for instructions on changing the Agilent SAS line voltage configuration.

The supplied cord connects to the power receptacle on the rear panel (②, Figure 2-1).

- You can operate your Agilent SAS from a nominal 100 V, 120 V, 220 V, 230 V, or 240 V single-phase ac line as indicated on the rear panel line **Rating** label ①.
- See "AC Input Ratings" in table A-1 or table A-2 in appendix A for the voltage and frequency range for the Agilent SAS. Refer to "Maximum AC Line Current Ratings" for the maximum load current.
- The line fuse is located in a fuseholder on the rear panel ③. The rear panel label shows the fuse value used in the unit. See Operator Replaceable Parts in chapter 1 for replacement fuse information.

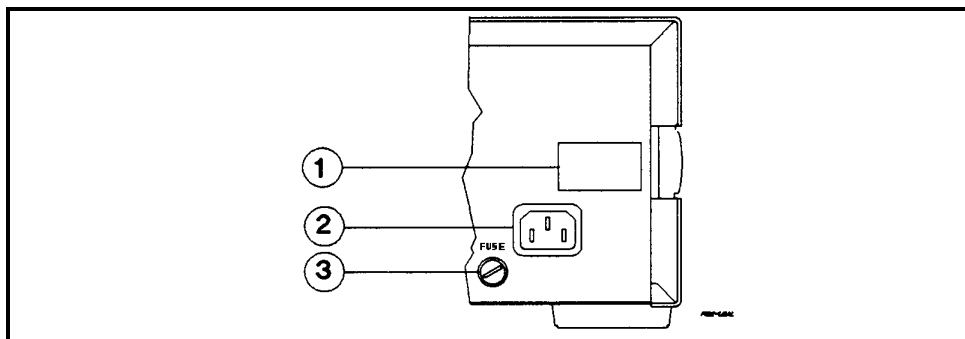

Figure 2-1. Agilent SAS Power Connection

AC Line Voltage Conversion

WARNING

SHOCK HAZARD. Hazardous voltage can remain inside the unit even after it has been turned off. This procedure should only be done by qualified electronics service personnel.

Line voltage conversion is accomplished by changing wire and jumper positions on the ac input of the main power transformer. Proceed as follows:

1. Turn off the ac power to the unit and disconnect the power cord from the ac line.
2. Remove the four screws that secure the two carrying straps and outer cover.
3. Slightly spread the bottom rear of the cover and pull it back to disengage it from the front panel.
4. Slide the dust cover back far enough to expose the line select jumpers (see figure 2-2).
5. Move the line voltage select jumpers to the positions corresponding to the desired line voltage. To disconnect it from the transformer tab, pull the wire straight up. Moving the wire from side-to-side can damage the tab.
7. Replace the top cover and secure the carrying straps.
8. Change the line fuse (on the rear panel) to the proper value for the new line voltage .

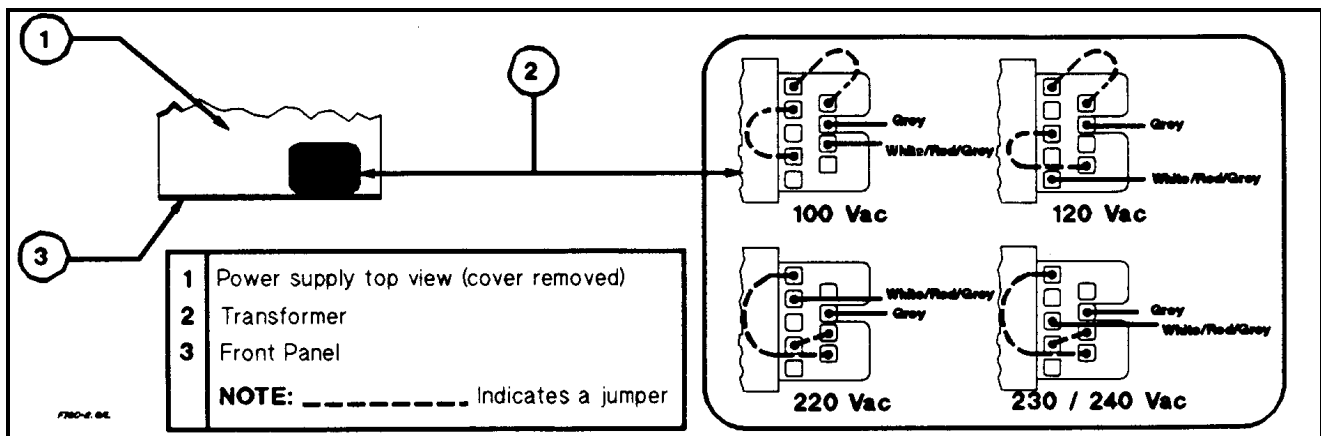

Figure 2-2. Agilent SAS Line Select Jumpers

VXI *plug&play* Power Products Instrument Drivers

VXI *plug&play* Power Products instrument drivers for Microsoft Windows 95 and Windows NT are now available on the Web at <http://www.agilent.com/find/drivers>. These instrument drivers provide a high-level programming interface to your Agilent Power Products instrument. VXI *plug&play* instrument drivers are an alternative to programming your instrument with SCPI command strings. Because the instrument driver's function calls work together on top of the VISA I/O library, a single instrument driver can be used with multiple application environments.

Supported Applications

- Agilent VEE
- Microsoft Visual BASIC
- Microsoft Visual C/C++
- Borland C/C++
- National Instruments LabVIEW
- National Instruments LabWindows/CVI

System Requirements

The VXI *plug&play* Power Products instrument driver complies with the following:

- Microsoft Windows 95
- Microsoft Windows NT 4.0
- HP VISA revision F.01.02
- National Instruments VISA 1.1

Downloading and Installing the Driver

NOTE: Before installing the VXI plug&play instrument driver, make sure that you have one of the supported applications installed and running on your computer.

1. Access Agilent Technologies' Web site at <http://www.agilent.com/find/drivers>.
2. Select the instrument for which you need the driver.
3. Click on the driver, either Windows 95 or Windows NT, and download the executable file to your pc.
4. Locate the file that you downloaded from the Web. From the **Start** menu select **Run** <path>:\agxxxx.exe - where <path> is the directory path where the file is located, and agxxxx is the instrument driver that you downloaded .
5. Follow the directions on the screen to install the software. The default installation selections will work in most cases. The readme.txt file contains product updates or corrections that are not documented in the on-line help. If you decide to install this file, use any text editor to open and read it.
6. To use the VXI *plug&play* instrument driver, follow the directions in the VXI *plug&play* online help under "Introduction to Programming".

Accessing Online Help

A comprehensive online programming reference is provided with the driver. It describes how to get started using the instrument driver with Agilent VEE, LabVIEW, and LabWindows. It includes complete descriptions of all function calls as well as example programs in C/C++ and Visual BASIC.

- To access the online help when you have chosen the default Vxipnp start folder, click on the Start button and select Programs | Vxipnp | Agxxxx Help (32-bit).
- where Agxxxx is the instrument driver.

Turn-On Checkout

Introduction

Successful tests in this chapter provide a high degree of confidence that the Agilent SAS is operating properly. For verification tests, see appendix B under Verification. **Do not apply ac power to the Agilent SAS until told to do so.**

Note This chapter provides a preliminary introduction to the Agilent SAS front panel. See chapter 5 - Front Panel Operation for more details. During this procedure, the Agilent SAS is operating in Fixed mode.

Preliminary Checkout

1. Make certain that the front panel switch is off.
2. Examine the Line Fuse Rating label on the rear panel.
 - a. Verify that the line voltage rating agrees with your ac line. If it does not, see chapter 2 under AC Line Voltage Conversion.
 - b. Use a screwdriver to remove the line fuse from the fuseholder. Verify that the fuse is as specified on the label. Replace the fuse.
3. Check that the SENSE switch is set to Local.
4. Make sure that there is no load connected to the output terminals or bus bars.

Power-On Checkout

1. Connect the power cord to the unit.
2. Turn the front panel power switch to ON (1).
3. The Agilent SAS undergoes a self-test when you turn it on. If the test is normal, the following sequence appears on the LCD:
 - a. * * * * * a brief star-burst pattern which lights all the LCDs, followed by
 - b. **ADDR 5** the GPIB address (factory default is 5).
4. The display then goes into the meter mode with the **Dis** annunciator on and all others off. "Meter mode" means that the **VOLTS** digits indicate the output voltage and the **AMPS** digits indicate the output current. These values will be at or near zero.
5. Verify that the Agilent SAS fan is on by placing your hand near the rear grill to feel the air flow. You may also be able to hear the fan operating.
6. Press **Output on/off** once. The **Dis** annunciator will go off and the CV annunciator will go on .

Note If the Agilent SAS detects an error during self-test, the display will show an error message. Go to "In Case of Trouble" at the end of this chapter.

Using The Keypad

Shifted Keys

Some of the front panel keys perform two functions, one labeled in black and the other in blue. You access the blue function by first pressing the blue **Shift** key, which is not labeled. When the **Shift** annunciator is on, you will know you have access to the key's shifted (blue) function.

Backspace Key

The **←** key is an erase key. If you make a mistake entering a number and have not yet entered it (have not pressed **Enter**), you can delete the number by pressing **←**. You may delete as many numbers as you wish by repeatedly pressing this key.

Output Checkout

Important When the Agilent SAS is turned on, it asserts the state stored in EEPROM memory location 0. For a new unit, this is the factory default (*RST) state. The following procedures assume that the factory default state is still in location 0 (see Turn-On Conditions in chapter 5 for details).

Checking the Voltage Function

The tests in Table 3-1 check the basic voltage functions with no load connected to the Agilent SAS. These test are possible only from the front panel when the unit is operating in **Fixed** mode. The **VOLTS** display will show various readings. Ignore the **AMPS** display.

Table 3-1. Checking the Voltage Functions with Output Terminals Open

Procedure	Display	Explanation
Either leave the output terminals open or connect them to a voltmeter.		
If the Dis annunciator is on, turn it off by pressing Output on/off		
Press Voltage key	VOLT 0.000	Default voltage setting. CV annunciator should be on. (If CC annunciator is on, increase the current by pressing ↑Current one or more times until CC turns off and CV turns on.)
Press 4 0	VOLT 40	Program output to 40 volts.
Press Enter	40.00	Enter the voltage. Meter mode displays output voltage. During these tests, there may be a small (relative to full output) AMPS reading that will be ignored.
Press ↓Voltage several times		Voltage decreases several millivolts each time you press the key.
Press ↑Voltage the same number of times		Voltage increases several millivolts each time you press the key.

Table 3-1. Checking the Voltage Functions with Output Terminals Open (continued)

Procedure	Display	Explanation
Rotate the Voltage control first counterclockwise and then clockwise		Control operates similarly to ↓Voltage and ↑Voltage keys. The control is rate sensitive. Turning it more quickly causes a more rapid change in voltage.
Press ↑Voltage 4 0 Enter	40.00	Program the output to 40 volts.
Press OV		Display shows default OVP (overvoltage protection) trip voltage for your unit (see Supplemental Characteristics in appendix A).
Press 3 0	OV 30	Program the OVP to 30 volts, which is less than the output voltage.
Press Enter	0.000	OVP voltage entered is less than the output voltage. This causes the OVP circuit to trip. The output drops to zero, CV turns off, and Prot turns on.
Press Protect	OV - - - -	Shows that the Agilent SAS shuts down because the OVP circuit has tripped.
Press ←		Return display to meter mode (optional step).
Press OV 5 0 Enter	0.000	Program the OVP to 50 volts, which is greater than the output voltage. Note: You cannot clear an OVP trip until you have first removed the cause of the condition.
Press Prot Clear (Shift) (Protect)*	40.00	The OVP circuit is cleared, restoring the output. Prot turns off and CV turns on.

***Shift** is the unlabeled blue key.

Checking the Current Function

The tests in Table 3-2 check the basic current functions with a short connected across the Agilent SAS output. These tests are possible only from the front panel when the unit is operating in **Fixed** mode. **Do not program maximum output currents unless the shorting wire is capable of handling the current** (see Supplemental Characteristics in appendix A and table 4-1). The **AMPS** display will show various readings. Ignore the **VOLTS** display.

Table 3-2. Checking the Current Functions with Output Terminals Shorted

Action	Display	Explanation
Turn off the Agilent SAS and connect a #18 AWG or larger wire across the output (+) and (-) terminals. If you intend to test at full-rated output current, use a wire or wires of sufficient size to carry the maximum current of the unit (see Supplemental Characteristics in appendix A and table 4-1 in Chapter 4).		
Turn on the unit. Set the voltage to its maximum value. This example assumes that you have an 60-volt unit (see Table 7-3 for the value for your specific unit).	Meter mode	Essentially zero outputs with Dis annunciator on.

Table 3-2. Checking the Current Functions with Output Terminals Shorted (continued)

Action	Display	Explanation
Press Voltage 6 0 Enter	VOLT 60.000	Program output to 60 volts.
Press Current 1 Enter	AMPS 1.000	Program output to 1 ampere.
Press Output on/off	AMPS 1.000	Dis annunciator turns off, CC annunciator turns on, and AMPS display shows the programmed current. The output voltage should be close to zero volts.
Press ↓Current several times		Current decreases several milliamperes each time you press the key.
Press ↑Current the same number of times		Current increases several milliamperes each time you press the key.
Rotate the Current control first counterclockwise and then clockwise		Control operates similarly to the ↓Current and ↑Current keys. The control is rate sensitive. Turning it more quickly causes a more rapid change in current.
Press OCP		You have enabled the overcurrent protection circuit. The circuit then tripped because of the output short. The CC annunciator turns off and the OCP and Prot annunciators come on. The output current is near zero. Note that the overcurrent protection circuit is disabled in Simulator and in Table modes.
Press Output on/off	AMPS 0.000	Dis annunciator turns on.
Press OCP		You have disabled the overcurrent protection circuit. The OCP annunciator turns off.
Press Prot Clear (Shift) (Protect) *		You have cleared the overcurrent protection circuit. The Prot annunciator turns off.
Press Output on/off	AMPS 1.000	Dis turns off and CC turns on. The output current is restored.
If you have a shorting wire of sufficient capacity, you may continue testing up to the maximum rated current of the Agilent SAS (see Performance Specifications in appendix A). When finished, go to the next step.		
Press Output on/off	AMPS 0.000	Dis turns on and output current drops to zero.
Turn off the Agilent SAS and remove the short from the output terminals.		
* (Shift) is the unlabeled blue key.		

Checking The Save And Recall Functions

The Save and Recall functions are applicable to the Agilent SAS in Fixed mode only. Note that in Simulator or in Table modes, the Save function is ignored, the recall will return the unit to the Fixed mode and reset the parameters to the *RST values (refer to the discussion of *RCL in chapter 7). The Agilent SAS has five nonvolatile memory storage locations (0 through 4). Proceed as follows:

- Make certain that the output is on (**Dis** annunciator is off).
- Set the voltage output to 5 by pressing **Voltage** **5** **Enter**.
- Save this value to location 1 by pressing **Shift** **Save** **1** **Enter**.
- Return the output voltage to 0 by pressing **Recall** **0** **Enter** (This step is based on the fact that a newly shipped Agilent SAS has the *RST parameters stored in location 0 (see chapter 5 - Front Panel Operation for more information).
- Press **Recall** **1** **Enter** and notice that the output voltage returns to the value stored in location 1.

Determining The GPIB Address

When the Agilent SAS is turned on, the display shows ADDR n, where n is the Agilent SAS GPIB address. Any time you want to see the address, press **Address**.

The display will indicate ADDR 5, which is the factory default. If the address has been changed, then a different number will appear (see Setting the GPIB Address in chapter 5).

In Case Of Trouble

Line Fuse

If your unit appears dead with a blank display and the fan not running, first check your ac line to be certain that voltage is being supplied to the Agilent SAS. If the power source is normal, the Agilent SAS line fuse may be defective. If the unit has a defective fuse, replace it only once. If it fails again, investigate the reason for the failure.

The line fuse is located on the rear panel. To change the fuse proceed as follows:

1. Turn off the front panel power switch.
2. Using a screwdriver, remove the fuse from the fuseholder. Replace it with one of the same type (see table 1-3 in chapter 1).
3. Turn on the Agilent SAS and check the operation.

Error Messages

Agilent SAS failure may occur during power-on selftest or during operation. In either case, the display may show an error message that indicates the reason for the failure.

Selftest Errors

When a selftest error occurs, it prevents all front panel operation. The display may show either a power-on error message or a checksum error message.

Power-On Error Messages

Power-on messages appear as:

En- - - - -

Where "n" is a number listed in Table 3-3. If this occurs, turn the power off and then back on to see if the error persists. It is possible to recover from the EE CHKSUM error (see "Checksum Errors"). If any other message persists, the Agilent SAS requires service.

Table 3-3. Power-On Selftest Errors

Error No.	Display	Failed Test	Error No.	Display	Failed Test
E1	FP RAM	Front Panel RAM	E8	SEC RAM	Secondary RAM
E2	FP ROM	Front Panel ROM checksum	E9	SEC ROM	Secondary ROM checksum
E3	EE CHKSUM	EEPROM	E10	SEC 5V	Secondary 5 V ADC reading
E4	PRI XRAM	Primary external RAM	E11	TEMP	Secondary ambient thermistor reading
E5	PRI IRAM	Primary internal RAM			
E6	PRI ROM	Primary ROM checksum	E12	DACS	Secondary VDAC/IDAC readback
E7	GPIB	GPB R/W to serial poll			

Checksum Errors.

If the display shows **EE CHKSUM**, the Agilent SAS has detected an EEPROM checksum error. A checksum error can occur due to the following conditions:

- Excessive number of write cycles to an EEPROM (see "Supplemental Characteristics"). This condition, which would appear only after extended use, is not recoverable and requires service.
- Loss of ac input power during a checksum calculation. This condition, which is very unlikely, is recoverable.

You may be able to recover from a checksum error by writing to the EEPROM while the Agilent SAS is in the calibration mode. To do this, proceed as follows:

1. Enable the calibration mode by pressing **Shift Cal Enable 1 Enter**.
2. **PASWD** will appear on the display.
3. Press the number keys corresponding to the password, followed by **Enter**. The **Cal** annunciator will go on.

Note On new equipment, the default calibration password corresponds to the model number (such as 4350). See appendix B under Changing the Calibration Password for more information.

4. Save any operating state (for example, press **Shift Save 0 Enter**).
5. Turn the power off and then back on.

A normal display free of error messages should appear. If not, the Agilent SAS requires service.

Runtime Error Messages

Under unusual operating conditions, the **VOLT** or **AMPS** display may show **+OL** or **-OL**. This indicates that either the output voltage or current is beyond the range of the meter readback circuit, or that the value that is programmed is out of range. Table 3-4 shows other error messages that may appear at runtime.

Table 3-4. Runtime Errors

Display	Meaning	Display	Meaning
EE WRITE ERR	EEPROM status timeout	UART FRAMING	UART byte framing error
SBUF FULL	Message too long for buffer	UART OVERRUN	Overfilled UART receive buffer
SERIAL DOWN	Failed communication with front panel	UART PARITY	UART byte parity error panel
STK OVERFLOW	Front panel stack overflow		

User Connections

Rear Panel Connections

Make application load connections to the output terminals or bus bars, analog connector, and digital connector as shown on the rear-panel drawing for your model Agilent SAS. Make controller connections (GPIB and serial link) as shown in Figure 4-12 at the end of this chapter.

Wire Selection

WARNING

Fire Hazard To satisfy safety requirements, load wires must be large enough not to overheat when carrying the maximum short-circuit current of the Agilent SAS. If there is more than one load, then any pair of load wires must be capable of safely carrying the full-rated current of the unit.

Table 4-1 lists the characteristics of AWG (American Wire Gauge) copper wire.

Table 4-1. Wire Characteristics

AWG No.	Ampacity (in free air)	Resistance (at 20 deg. C)	
		Ω/m	Ω/ft
20	8.33	0.0345	0.01054
18	15.4	0.0217	0.00663
16	19.4	0.0137	0.00417
14	31.2	0.0086	0.00262
12	40	0.0054	0.00165

Analog Connector

This connector, which is on the rear panel, is for connecting remote sense leads, external current monitors, and external current programming sources. The connector accepts wire sizes from AWG 22 to AWG 12.

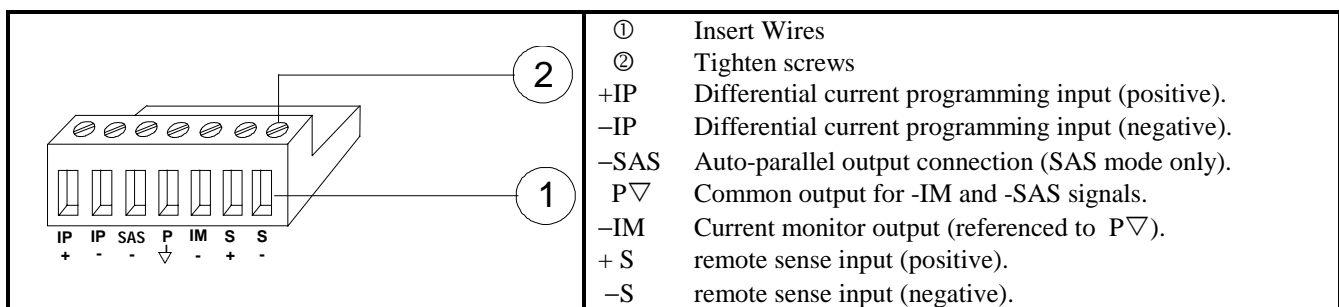

Figure 4-1. Rear Panel Analog Connector

Note

It is good engineering practice to twist or shield all signal wires to and from the analog and digital connectors.

To minimize spurious operation, make sure that all analog wiring except for the + and - sense wires does not exceed 3 meters in length.

Digital Connector

This connector, which is on the rear panel, is for connecting fault/inhibit, digital I/O, or relay link signals. The connector accepts wires sizes from AWG 22 to AWG 12.

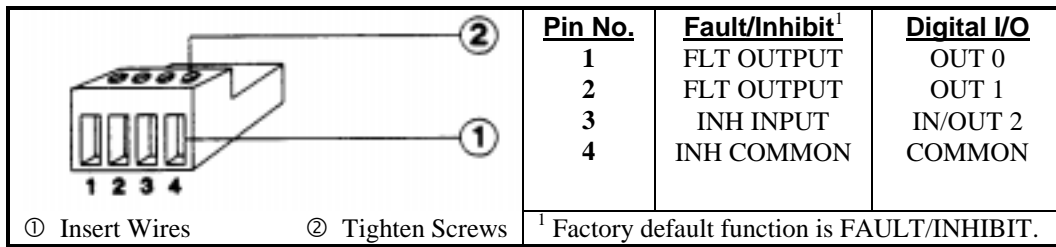

Figure 4-2. Rear Panel Digital Connector

Load Connections

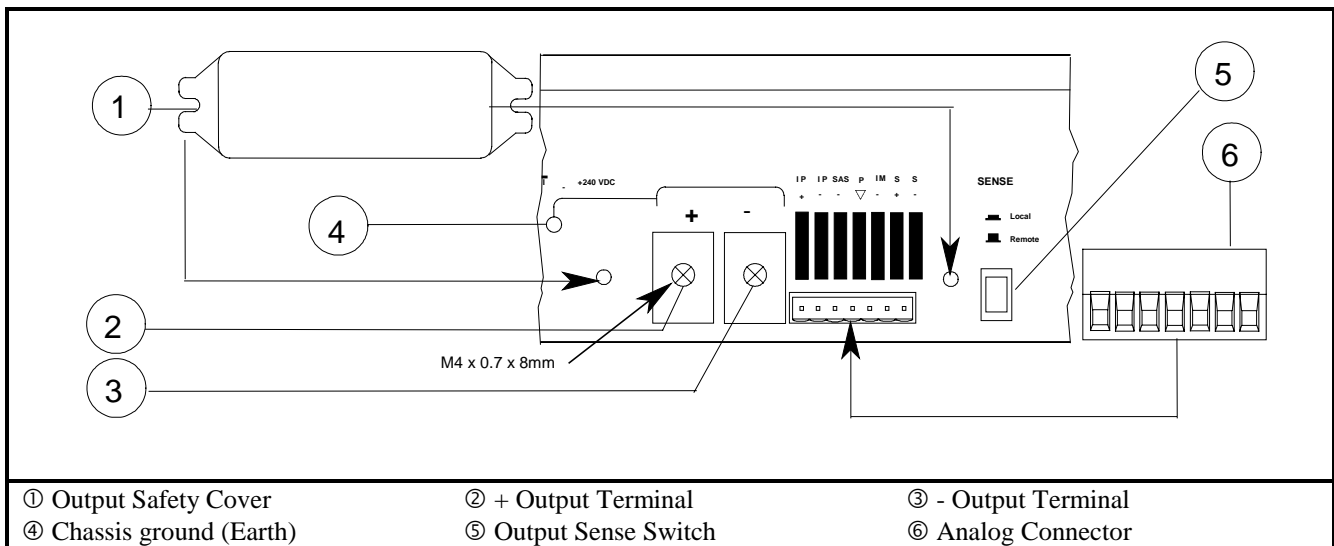

Figure 4-3. SAS Rear Panel Output Connections

Output Isolation

The output of the Agilent SAS has dc isolation from earth ground. Either output terminal may be grounded, or an external voltage source may be connected between either output and ground. However, both output terminals must be kept within ± 240 Vdc of ground. An earth ground terminal is provided on the rear panel for convenience, such as grounding wire shields.

WARNING

The earth ground terminal on the rear panel is a low-noise signal ground for convenience only. It is not designed to function as a safety ground.

Capacitive Loads

In Fixed Mode Operation, the maximum external capacitance that may be added to the output without causing instability is 2,000 μ F. This is also the maximum capacitance value that can be safely discharged by the OVP (overvoltage protection) circuit.

CAUTION

Because of its high output voltage, the Agilent E4351B generates high currents when discharging the load capacitor under overvoltage conditions. Excessive currents can damage the unit. The peak discharge current is limited by the sum of the external capacitor's ESR (equivalent series resistance) and the series resistance of the external circuit. For the Agilent E4351B's external capacitance limit of 2,000 μF , the total resistance must not be less than 56 milliohms. For smaller values of external capacitance, the total resistance may be derated linearly.

Inductive Loads

When operating in Simulator mode, load inductance should be kept under 200 μH . For twisted pair wires or zipcord, figure approximately 0.25 μH per foot of load lead wire.

Connecting to an External Voltage Source

The Agilent SAS's overvoltage circuit contains a crowbar SCR that effectively shorts the output of the unit whenever OVP trips.

Note If the OVP trips, you must remove any external source of current in order to reset the internal SCR as part of clearing the OVP circuit (see Clearing the OV Condition in chapter 8).

If an external voltage source such as a battery is connected across the output and the OVP is inadvertently triggered, the Agilent SAS will continuously sink a large current from the source. This could damage the Agilent SAS. To avoid this, insert a reverse blocking diode in series with either output of the Agilent SAS in the direction of normal output current flow. The diode's voltage rating should be at least 150% of the HP SAS's output voltage rating. The diode may also require a heat sink.

Sense Connections

Your Agilent SAS was shipped set up for local sensing. This means that the unit will sense and regulate its output voltage at the output terminals, with the load voltage being somewhat lower due to load lead voltage drop. Where load voltage regulation is critical, remote sensing may be required.

Local sensing is obtained by placing the SENSE switch (see Figure 4-3) in the **Local** position (button in). The Agilent SAS is shipped with the switch in this position.

Note If the sense terminals are left unconnected with the sense switch in the Remote position, the voltage at the output will increase approximately 3 to 5 % over the programmed value. Since the front panel meter measures the output voltage at the sense terminals, the voltage readback will not reflect this increase.

Remote Voltage Sensing

Optional Remote sense connections are illustrated in most of the load diagrams. Remote sensing is accomplished by connecting the remote sense terminals of the Agilent SAS directly to the load rather than to the output terminals. This allows the unit to automatically compensate for the voltage drop in the load leads as well as to accurately read back the voltage directly across the load.

In Fixed mode, the maximum allowable load lead drop that can be compensated for by remote sensing is 2 V. In Simulator and Table mode, the maximum allowable voltage drop in the load leads is 2 V + (Voc - Vmp).

The Agilent SAS is shipped with the switch in the **Local** position. Remote sensing is obtained by placing the SENSE switch (see Figure 4-3) in the **Remote** position. Connect the positive side of the load to the +S analog connector pin and the negative side of the load to the -S analog connector pin (see Figure 4-1). Connect the sense leads carefully so that they do not become open-circuited. If sense leads are left open during operation, the unit will regulate at the output terminals instead

of at the load, but with a 3% to 5% increase in voltage at the output terminals. Bundle or tie wrap the load leads to minimize inductance and reduce noise pickup.

CV Regulation

The Fixed mode voltage load regulation specification in appendix A applies at the output terminals of the Agilent SAS. When remote sensing, this specification must be adjusted by adding 3 mV to the voltage load regulation specification for each 1-volt change in the positive load lead due to a change in load current.

Because the sense leads are also part of the unit's feedback path, keep the resistance of the sense leads low in order to obtain the best performance. The additional load regulation due to resistance in the sense leads is given by the formula:

$$\text{Regulation in millivolts} = \frac{(\text{total load lead drop}) * (\text{total sense lead resistance})}{K}$$

where $K = 3$ for E4350B; 7 for E4351B

Overvoltage Protection Considerations

The OVP circuit senses the voltage at the output terminals, not at the sense terminals. With remote sensing, the voltage sensed by the OVP circuit will be higher than the voltage being maintained at the load. Therefore, when using remote sensing, you must program the OVP high enough to compensate for the expected voltage drop between the output and the load.

Output Rating

The rated output voltage and current specification in appendix A applies at the output terminals of the Agilent SAS. With remote sensing, any voltage dropped in the load leads causes the unit to increase the voltage at the output terminals so it can maintain the proper voltage at the load (see Remote Voltage Sensing). If you attempt to operate at the full-rated output at the load, this may force the voltage at the output terminals to exceed the unit's rated output.

This will not damage the unit, but may trip the OVP (overvoltage protection) circuit, which senses the voltage at the output. When operated beyond its rated output, the unit's performance specifications are not guaranteed, although typical performance may be good. If the excessive demand on the unit forces it to lose regulation, the **Unr** annunciator will indicate that the output is unregulated.

Output Noise

Any noise picked up on the sense leads also appears at the output of the Agilent SAS and may adversely affect the load voltage regulation. Be sure to twist the sense leads to minimize external noise pickup and route them parallel and close to the load leads. In noisy environments, it may be necessary to shield the sense leads. Ground the shield only at the Agilent SAS. *Do not use the shield as one of the sense conductors.*

Stability

In **Simulator** and **Table** modes, the unit is stable with constant current, constant resistance, constant voltage, and any capacitive loads. Inductive loads should be kept less than 200 μ H.

In **Fixed** mode, the unit is stable if the output capacitance is less than 2000 μ F.

Over Current Protection Considerations

The front panel overcurrent protection (OCP) is functional only when the Agilent SAS is operating in Fixed mode. This is because the normal function of the OCP circuit, when enabled, is to turn the output of the Agilent SAS off whenever the unit changes from constant voltage operation to constant current operation. Since constant current mode is the normal operating state of both Simulator and Table modes, the OCP key is disabled to prevent the output from turning off. Note that even though OCP is disabled, the OCP annunciator still lights when the OCP key is pushed in Simulator and Table modes.

The OCP protection level is the same as the output current limit setting. When the OCP is enabled in **Fixed** mode and the operating mode of the unit changes from constant voltage to constant current, the OCP circuit trips and turns the output off in approximately 200 milliseconds. This delay time can be adjusted with the `OUTPut:PROTection:DELAy` command. The **PROT** annunciator on the front panel display turns on when the OCP condition occurs. When reading the protection message in the front panel display, the reading will be **OC**.

Clear the OCP condition by pressing **Prot Clear** on the front panel or by sending an `OUTPut:PROTection:CLEAr` command over the GPIB. Note that you can program an `OUTPut:PROTection:DELAy` time to prevent nuisance tripping of the OCP circuit when it is enabled.

Hardware Overcurrent Circuit (OC)

The Agilent SAS has a hardware overcurrent circuit (OC) that protects the unit if the output current exceeds a preset value. Although active in all operating modes, this circuit is primarily provided for the Simulator and Table modes since both of these modes disable the constant-current OCP function. When tripped, the OC circuit shuts off the output and fires the internal SCR in approximately 50 to 100 microseconds.

Note The OC circuit limit can only be programmed over the GPIB using the `CURRent:PROTection` command. You cannot set the OC limit from the front panel, and you cannot program a delay time for this circuit.

When an overcurrent condition occurs in Simulator and Table modes, the **PROT** annunciator on the front panel display will turn on. The protect message reading on the front panel display will be **OV OC**. To return the Agilent SAS to normal operation, first remove the cause of the overcurrent. Then either press **Prot Clear** on the front panel or send an `OUTPut:PROTection:CLEAr` command over the GPIB.

Operating Configurations

Connecting the Load to One Unit

Figures 4-4 and 4-5 show how to connect a single Agilent SAS to one load and to multiple loads.

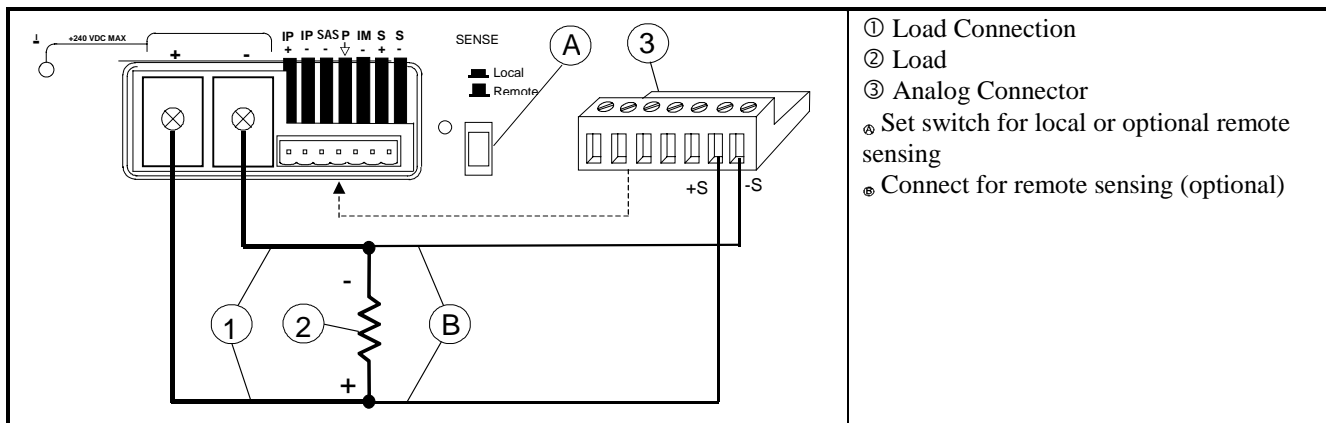

Figure 4-4. Single Load Connection

Connecting Supplies in Auto-Parallel

Auto-parallel connections are used only if it is required that the output currents of all paralleled units be accurately matched. Otherwise you can use straight parallel connections as described in the previous paragraphs.

Auto-Parallel Wiring in Simulator and Table Modes

Figure 4-7 illustrates how units can be connected in auto-parallel for increased current output in Simulator and Table modes. If remote sensing is required, connect the remote sense terminals of all the supplies to the load as shown in Figure 4-7.

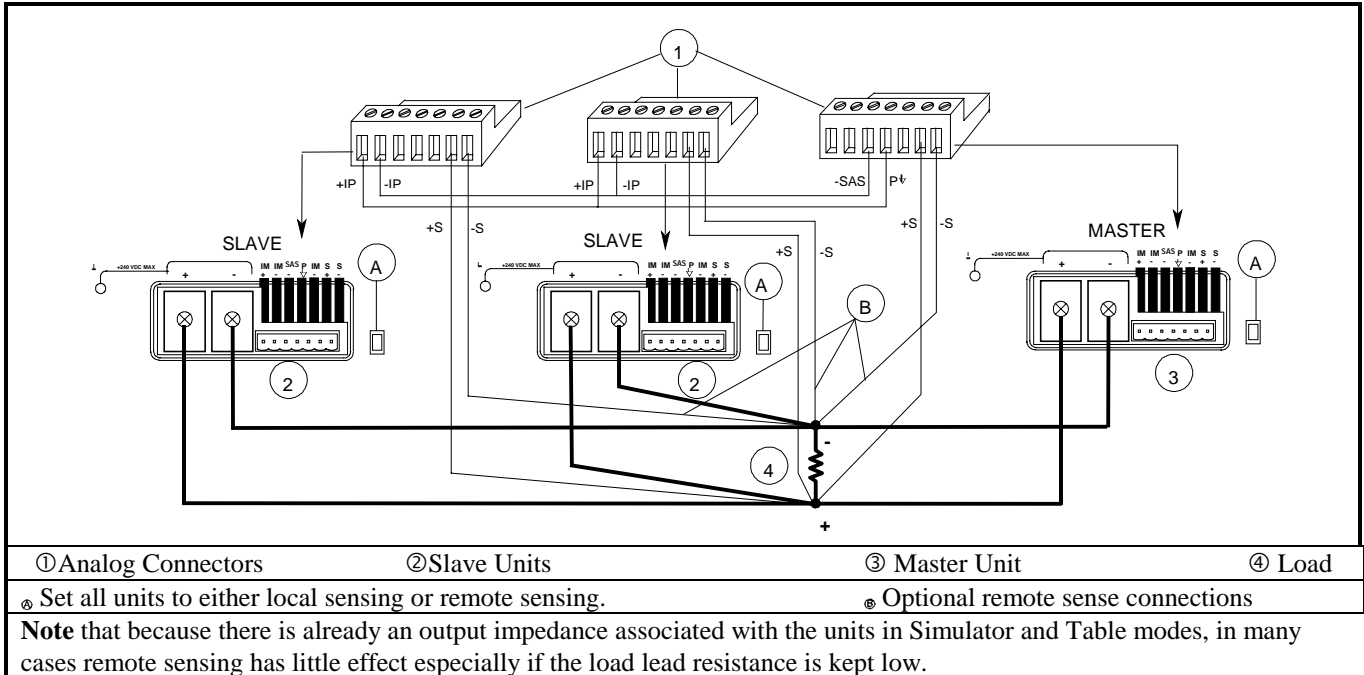

Figure 4-7. Auto-Parallel Connection in Simulator Mode (Remote Sensing Optional)

Auto-Parallel Programming in Simulator and Table modes

When operating in Simulator mode, all units must be programmed with identical curves. However the I_{sc} and I_{mp} values sent to the slave units must be set to zero (0). This is because in auto-parallel mode, the master unit controls the output current of the slave units. When operating in Table mode, all units must be programmed with identical table data. However, you must append a value of -999 at the end of the current data and a value of +999 at the end of the voltage data for slave units. This again allows the master unit to control the output current of the slave units. Refer to chapter 6 under Programming Units in Auto-parallel for a programming example.

Auto-Parallel Wiring in Fixed Mode

Figure 4-8 illustrates how units can be connected in auto-parallel for increased current output with current sharing. If remote sensing is required, connect the remote sense terminals of the master unit to the load as shown in Figure 4-8. To avoid output ringing, you can either connect a 2.2 μF or larger capacitor across the load, or you can connect a filter across the current monitoring connections as shown in the figure. This network consists of two 200 ohm resistors in series with the current monitoring lines going to the master unit, and a 68 ohm/0.1 μF RC paralleled across + and - IP terminals.

3. Remove or disable the Agilent SAS OVP crowbar SCR. For further information, contact an Agilent Service Engineer through your local Agilent Sales and Support Office.

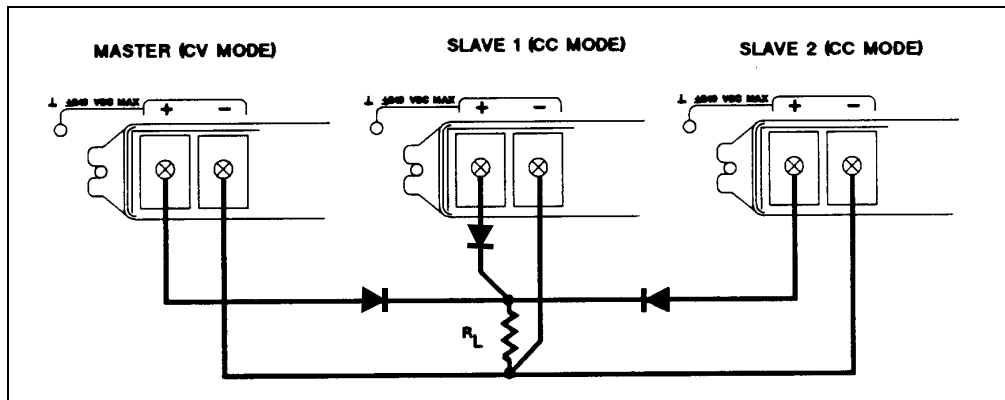

Figure 4-9. Using Series Diodes with Auto-Parallel Operation

Connecting Supplies in Series

WARNING

Only connect units in series that have identical voltage and current ratings. Floating voltages must not exceed ± 240 Vdc. No output terminal may be more than 240V from chassis ground. When operating in Simulator mode, units must be programmed with identical curves. When operating in Table mode, units must be programmed with identical table data.

Figure 4-10 shows how Agilent SAS units can be connected in series for higher voltage output. Series connections are straightforward in this case. Program each Agilent SAS independently. In **Fixed** mode, program each unit for 50% of the total output voltage. Set the current limit of each unit to the maximum that the load can handle without damage. In **Simulator** mode, the total Voc that will be provided is the sum of the open circuit voltages programmed for each individual unit.

CAUTION

Each Agilent SAS has a reverse voltage protection diode across its output. If a reverse voltage is applied, the unit cannot control the current conducted through this diode. To avoid damaging the unit, never connect it in such a way that a reverse voltage can force it to conduct current in excess of the unit's output current rating.

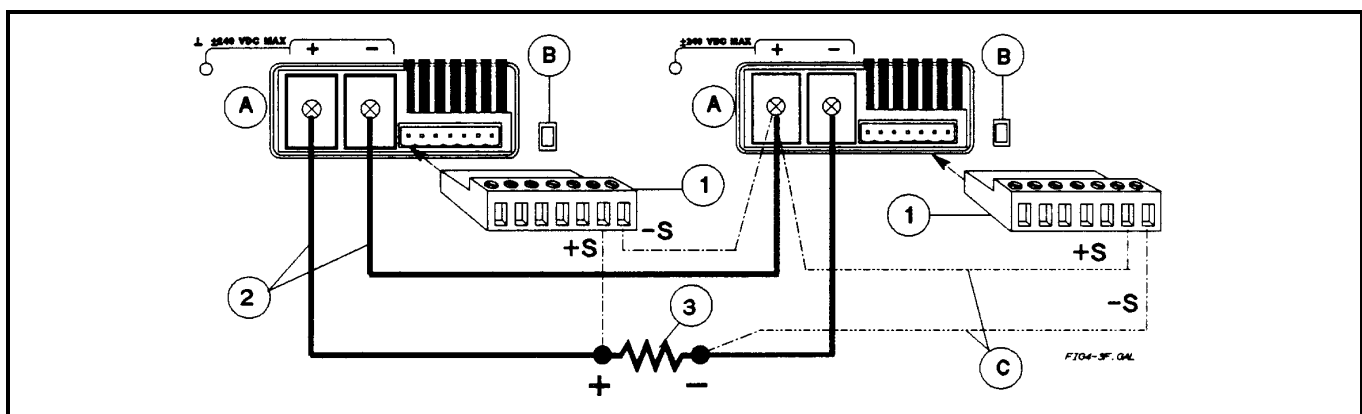

① Analog Connector

② Load Connection

③ Load

Ⓐ In Fixed mode, program each unit for 1/2 the load voltage. In SAS mode, the total Voc is the sum of the individual open circuit voltages of each unit.

Ⓑ Set switch for local or (optional) remote sensing

Ⓒ Optional remote sense connections

Figure 4-10. Series Connection (Remote Sensing Optional)

Analog Current Control (applies in Fixed mode only)

The setup shown in Figure 4-11 allows an external dc voltage to program the Agilent SAS output current in Fixed mode. A voltage applied to the differential current programming input programs the output current. Note that depending on the polarity of the external source, the external signal is either added to or subtracted from the front panel current setting. Output current is internally limited to a maximum of $\approx 112\%$ of the output current rating. If you want to fully control the output current through the analog input, you must first set the front panel current control to zero. A voltage of 0 to 4 volts programs the output current from zero amperes to the rated output current.

For proper operation, the maximum common-mode voltage between either the +IP or -IP inputs and the +OUT terminal should be kept to less than ± 18 volts. Note also that the input impedance of the analog input is $20\text{ k}\Omega$. If the output impedance of your programming source is not negligible compared to $20\text{ k}\Omega$, the programmed current will be less than expected.

Wiring Considerations

Be careful of capacitive coupling from the programming inputs to other lines wired to the analog connector. Such coupling can cause output oscillations and noise. You can minimize coupling by bundling the +IP and -IP lines and keeping them separated from other wires. Twisting these lines together is also recommended.

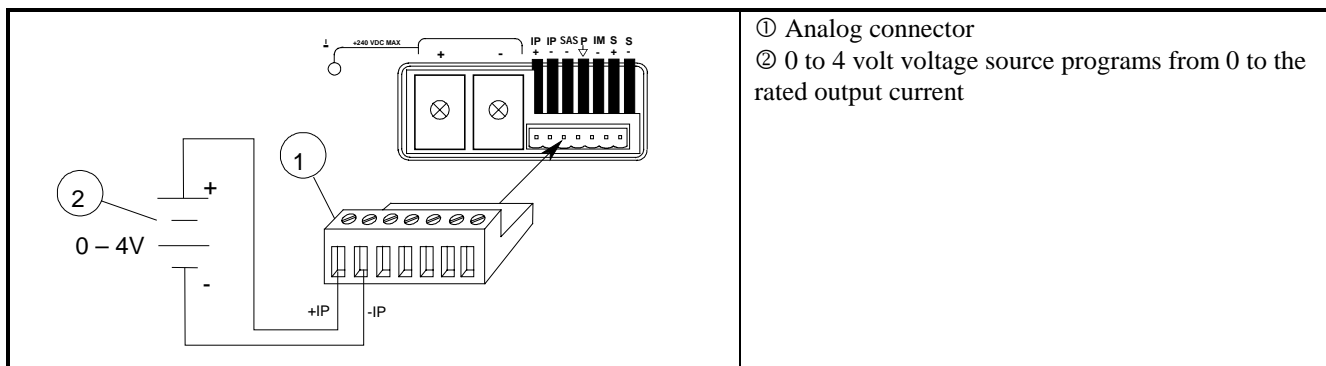

Figure 4-11. Analog Current Programming Connections

Controller Connections

Figure 4-12 shows two basic ways of connecting your Agilent SAS to a controller. They are "linked" and "stand-alone" configurations.

Stand-Alone Connections

See Figure 4-12A. Each stand-alone Agilent SAS has its own GPIB bus address. Stand-alone units may be connected to the bus in series configuration, star configuration, or a combination of the two. You may connect from 1 to 15 stand-alone units to a controller GPIB interface.

Linked Connections

See Figure 4-12B. Up to 16 units may be used at a single GPIB primary bus address by making linked connections.

- The first Agilent SAS in a linked connection is a "direct unit" connected to the controller via a GPIB cable. The direct unit is the only unit connected directly to the bus and has a unique primary bus address.
- The remaining units are "linked supplies" connected to the direct unit via a serial-link cable. Each linked unit has a unique secondary GPIB address and derives its primary address from the direct unit. You may connect from 1 to 15 linked supplies to each direct unit.

Note

The Agilent SAS is shipped from the factory with its GPIB address set to 5. The Agilent SAS primary and secondary addresses can be changed from the front panel as described under Changing the GPIB Address in chapter 5. For Agilent SAS GPIB interface capabilities, see appendix A.

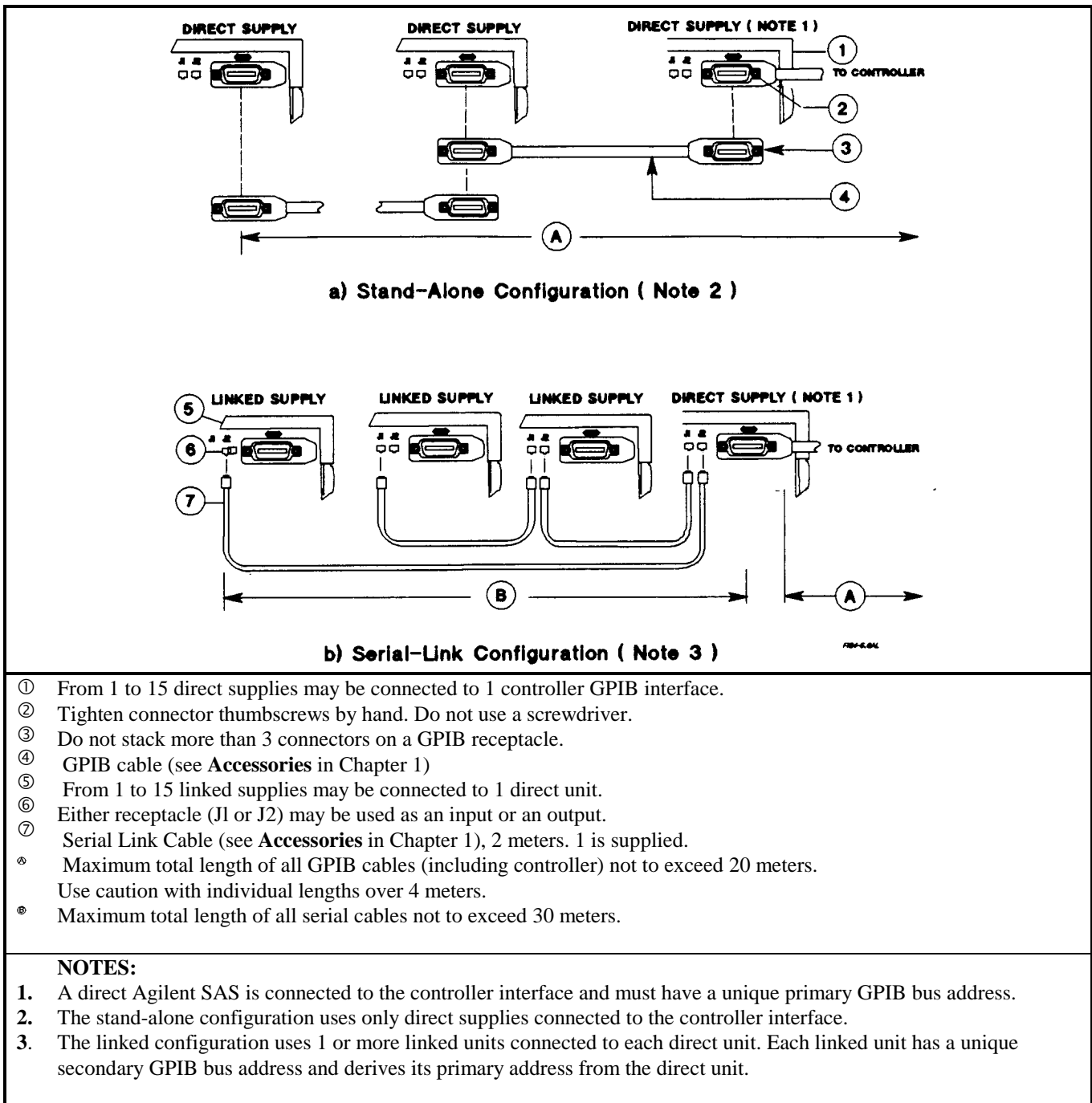

Figure 4-12. Controller Connections

Front Panel Operation

Introduction

Note Only in Fixed mode are front panel operations fully functional. The Agilent SAS can be operated as a standard dc source in Fixed mode. SAS functions are available when the unit is set to Simulator or Table mode. You cannot switch modes from the front panel. Modes can only be switched over the GPIB.

This chapter shows you how to operate the unit from front panel. It is assumed that you are familiar with the turn-on checkout procedure in chapter 3. That chapter describes how to perform basic functions from the control panel. Operations that you can perform are:

- Enabling or disabling the Agilent SAS output.
- Setting the output voltage and current.
- Monitoring the output voltage and current.
- Setting the overvoltage protection trip point.
- Enabling the overcurrent protection circuit (OCP).
- Clearing protection functions.
- Saving operating states in nonvolatile memory.
- Recalling operating states from nonvolatile memory.
- Setting the Agilent SAS GPIB bus address.
- Displaying error codes created during remote operation.
- Enabling local (front panel) operation.
- Calibration (see appendix B).

Key Functions

The front panel is summarized in Figure 5-1 and Table 5-1. Some keys have two functions. For example, the System **Recall** key can be used either to recall a stored operating state or to **Save** (store) an operating state. The first operation is shown **on** the key and the second (shifted) operation is shown in blue **above** the key. In order to do a shifted operation, first press the solid blue key, which is unlabeled but shown throughout this manual as **Shift**.

For example, for a recall operation, press the recall key **Recall**. For a save operation, press the Save key, which is **Shift Recall**. When you do this, the **Shift** annunciator will light to remind you that the **Recall** key is now functioning as the **Save** key. In this chapter, such a shifted operation may be shown simply as **Save**.

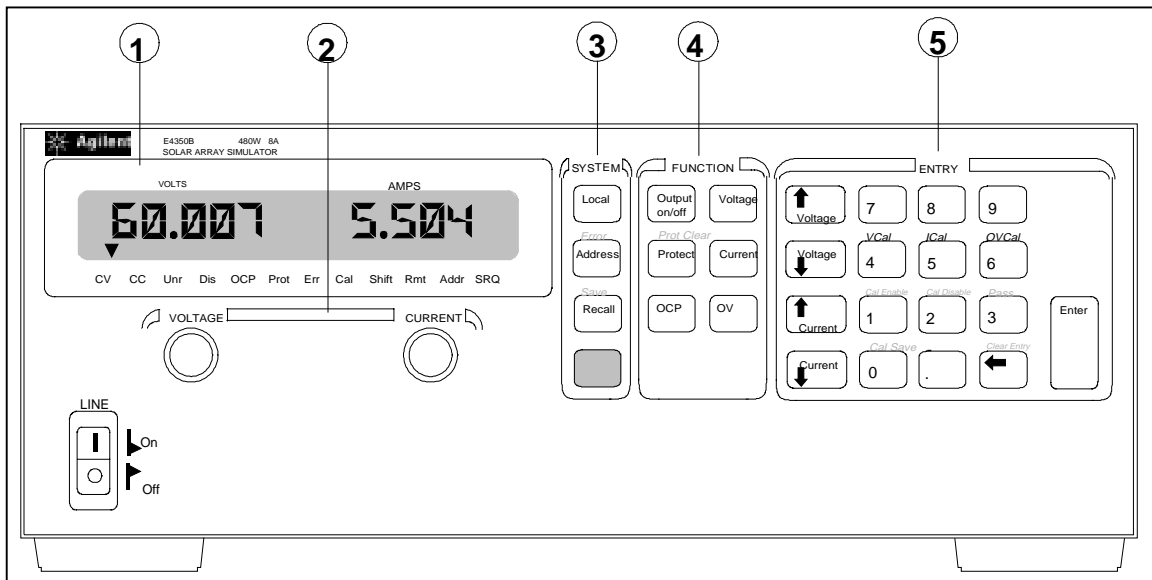

Figure 5-1. Front Panel Controls and Indicators

Table 5-1. Front Panel Controls and Indicators (See Figure 5-1)

Control or Indicator	Function or Indication
① Display	
VOLTS AMPS CV CC Unr Dis OCP Prot Err Cal Shift Rmt Addr SRQ	Shows present output voltage of the Agilent SAS. Shows present output current of the Agilent SAS. Status Annunciators The Agilent SAS is in constant-voltage mode. (Applies in Fixed mode only) The Agilent SAS is in constant-current mode. The Agilent SAS output is unregulated; the output is neither CV or CC. The Agilent SAS output is disabled. The Fixed mode overcurrent protection (OCP) function is enabled. (Applies in Fixed mode only.) A protection circuit has caused the Agilent SAS to shut down. (Press Protect to determine the reason.) An error has been generated as a result of remote operation. (Press Error to display the error code). The Agilent SAS is in calibration mode. The shift key Shift has been pressed. The Agilent SAS is in the remote mode (controlled over the GPIB). The Agilent SAS is addressed to listen or talk. The Agilent SAS is requesting service from the controller.
② Output Rotary Controls	
Voltage knob Current knob	Rotate clockwise to increase the output voltage or the voltage limit in constant current mode. Use to rapidly set an approximate output value. (Applies in Fixed mode only) Rotate clockwise to increase the output current or current limit in constant current mode. Use to rapidly set an approximate current value. (Applies in Fixed mode only)
③ SYSTEM Keys	
Local Address Error Recall Save 	When the Agilent SAS is under remote control, press to enable local operation. <i>This control can be defeated by a lock-out command over the GPIB</i> Press to display the Agilent SAS's GPIB address. You can change the address with the ENTRY keys Use to display error codes generated during remote operation. (Select by pressing Shift Address .) Use to restore a previously saved Agilent SAS state. Use ENTRY keys 0 through 4 to specify which location to recall. Note: Location 0 may contain the Agilent SAS turn-on state. See "Turn-on operation" in this chapter. Use to save the Agilent SAS's present state to nonvolatile memory. (Select by pressing Shift Recall .) Use ENTRY keys to specify the location where you want to store the state. You may use locations 0 through 4 . This unlabeled blue key is the Shift key. Press to access the shifted (alternate) key functions.

Table 5-1. Front Panel Controls and Indicators (continued)

④ Function Keys	
Output On/Off	<p>Press to enable or disable the Agilent SAS output. This key toggles between the two states. The disabled state programs the output to the *RST voltage and current settings.</p> <hr/> <p>Note To prevent current overshoots, do not use the Output On Off key when operating in CC mode. Current overshoots may occur when the output turns on because the unit momentarily goes to constant voltage mode before switching back to constant current mode. As an alternative, program the current to zero instead of using the Output On/Off key.</p>
Voltage	Press to display the output voltage setting. After pressing Voltage , you may use the ENTRY keys to change the value. (Applies in Fixed mode only)
Current	Press to display the output current setting. After pressing Current , you may use the ENTRY keys to change the value. (Applies in Fixed mode only)
OV	Press to display the OV trip voltage setting. After pressing OV , you may use the ENTRY keys to change the value.
Protect	When the Prot annunciator is on, press Protect to see which protection circuit caused the Agilent SAS to shut down. Response can be OC (overcurrent protection), OT (overtemperature), OV OC (hardware overcurrent), or OV (overvoltage). If no protection circuit has tripped, the display shows dashes (- - -).
Prot Clear	Press this key to reset the protection circuit. <i>If the condition that caused the circuit to trip has been removed</i> , the Prot annunciator will go off. (Select by pressing Shift Protect .)
OCP	Press to enable or disable the Fixed mode OCP function. This key toggles between the two states, which are indicated by the OCP annunciator. (Applies in Fixed mode only)
⑤ ENTRY Keys	
↑Voltage	Press to increment the output voltage in the CV mode, or to increase the voltage setting after you have pressed the Voltage key. Press and hold this key for an increasingly rapid change. (Fixed mode only)
↓Voltage	Press to decrement the output voltage in the CV mode, or to decrease the voltage setting after you have pressed the Voltage key. Press and hold this key for an increasingly rapid change. (Fixed mode only)
↑Current	Press to increment the output current in the CC mode, or to increase the current setting after you have pressed the Current key. Press and hold this key for an increasingly rapid change. (Fixed mode only)
↓Current	Press to decrement the output current in the CC mode, or to decrease the current setting after you have pressed the Current key. Press and hold this key for an increasingly rapid change. (Fixed mode only)
0 - 9	Press to select numerical values .
-	Press to enter a minus sign.
←	Press to delete the last keypad entry. Use this key to remove incorrect digits before they are entered.
Clear Entry	Press to delete an entire keypad entry and return to the meter mode. Use this key to exit from a value before it is entered. (Select by pressing Shift ← .)
Enter	Press to enter a value or to accept an existing value and return the display to the meter mode. The remaining shifted keys are for calibration (see appendix B - Calibration).

Programming the Output

Important These instructions show how to program a single Agilent SAS from the front panel. These instructions apply primarily when the unit is set to operate in Fixed mode. For example, any voltage and current values that you enter from the front panel will have no effect on the unit while it is in Simulator or Table modes but will take effect as soon as the unit is placed in Fixed mode. Likewise, the OCP function only takes effect in Fixed mode. There are also special considerations when you have two or more supplies connected in series or in parallel. See chapter 4 - User Connections and Considerations.

The Agilent SAS accepts values directly in volts and amperes. Values will be rounded off to the nearest multiple of the output resolution (see “Average Resolution” in appendix A). If you attempt to enter a value not in a valid range, the entry will be ignored and **OUT OF RANGE** appears on the display.

Figure 1-1 on page 1-3 shows the general response of a typical unit in Fixed mode. Always keep the output voltage and current within the boundaries of its operating line for the specified mode of operation (CV or CC).

Establishing Initial Conditions

Set the Agilent SAS to its *RST state by pressing **Recall 0 Enter**. This state was stored in location 0 at the factory. If it has since been changed, you can restore it as directed under “Turn-on Conditions”, later in this chapter. *RST results in the following operating conditions:

- Zero voltage output.
- Minimal current output.
- Output disabled (**Dis** annunciator on).
- Overvoltage protection set to its maximum value.
- Overcurrent protection off (**OCP** annunciator off).
- Hardware overcurrent protection set to its maximum value.
- Protection circuits cleared (**Prot** annunciator off).

Programming Voltage

To program the output for 45 volts, proceed as follows:

- Press **Voltage**. The display will change from meter mode to indicate **VOLTS**.
- Press **4 5 Enter**. If you discover a mistake before pressing **Enter**, erase the incorrect value with the backspace key **←**.
- The display will return to the meter mode and indicate 00.00 volts.
- Press **Output On/Off** to enable the output (**Dis** annunciator turns off). The **VOLTS** display will indicate 45.0 volts.

Note The Agilent SAS must be programmed for a minimal current in order to increase the output voltage beyond zero. If the Agilent SAS does not respond or the **CC** annunciator turns on, go to “Programming Current” and set the current to a small value.

- Now raise the voltage by pressing **↑Voltage**. Note that the voltage increases by a specific increment (depending on the voltage programming resolution) each time you press the key and increases rapidly as you hold down the key. To lower the voltage, press **↓Voltage**.
- Try raising and lowering the voltage by rotating the **Voltage** control clockwise and then counterclockwise. Note how the output responds as compared to using the **Entry** keys.

Try to program a voltage greater than the maximum voltage rating for your unit (see Supplemental Characteristics in appendix A). Note that the display shows **OUT OF RANGE**.

Programming Current

You may program the Agilent SAS current without a load, but must have a load in order to draw output current. These tests assume you have the load connected in accordance with the information in chapter 4 - User Connections and Considerations. If you do not have a load on the Agilent SAS, you may connect a short across the output terminals as described in chapter 3 - Turn-on Checkout.

The example will program a low current. (You may later increase the output current to the levels you will expect to use.) To program the output current to 1.3 amperes, proceed as follows:

- Disable the output by pressing **Output On/Off**. The **Dis** annunciator will turn on.
- Program the voltage by pressing **Voltage** **5** **0** **Enter**.
- Press **Current**. The display will change from meter mode to indicate **AMPS**.
- Press **1** **.** **3** **Enter**. If you discover a mistake before pressing **Enter** erase the incorrect value with the backspace key **←**.
- The display will return to the meter mode and indicate up to 0.000.
- Press **Output On/Off** to enable the output. **Dis** will turn off and the display will indicate **VOLTS 50.00 AMPS 1. 300**.
- Now increase the current by pressing **↑Current**. Note that the current increases by a specific increment (depending on the current programming resolution) each time you press the key and increases rapidly as you hold down the key. To decrease the current, press **↓Current**.
- Try increasing and decreasing the current by rotating the **Current** knob clockwise and counterclockwise. Note how the output responds as compared to using the **Entry** keys.

Disable the output by pressing **Output On/Off**. The **Dis** annunciator will turn on. Now try to program a current greater than the I_{MAX} for your unit. Note that the display shows **OUT OF RANGE**.

Programming Overvoltage Protection

Overvoltage protection guards the load against voltages that reach a specified value above the programmed output voltage.

Setting the OVP Level

Assuming that you have programmed the Agilent SAS for 45 volts, you can set the OVP level to 48 volts as follows:

- Press **OV**. The display will change from meter mode to indicate **OV**, followed by the present OVP value.
- Press **4** **8** **Enter**.
- The display will return to the meter mode and indicate the output voltage (45.00 volts).
- Press **OV** again. The display will now indicate **OV 48. 00**.
- Press **Enter** to return to the meter mode.

Checking OVP Operation

Assuming the above operating conditions (voltage programmed to 45 V and OVP programmed to 48 V), trip the OVP circuit as follows:

- Gradually increase the output voltage by pressing **↑Voltage** until the OVP circuit trips. This will cause the output voltage to drop to zero and the **Prot** annunciator to go on.
- There now is no Agilent SAS output due to an overvoltage condition.
- To verify this, press **Protect** and observe that the display indicates **OV**. This shows that the protection circuit tripped due to an overvoltage condition.

Clearing The OVP Condition

With the OVP tripped, return to the meter mode and try to clear the condition by pressing **Prot Clear**. Nothing will appear to happen because the OV trip voltage is still below the programmed output voltage. Thus, as soon as the circuit is cleared, it trips again. You can clear the OV condition by:

- Lowering the output voltage below 48 (the OV setting), or
- By raising the OV trip voltage above the output voltage setting.

Try either of these methods. Now when you press **Prot Clear**, the **Prot** annunciator will turn off and the output voltage will return to normal.

Programming Overcurrent Protection

When enabled, overcurrent protection removes the Agilent SAS output whenever it goes into CC operation. This prevents the unit from indefinitely supplying the full programmed current to the load.

Note This constant-current OCP feature is only available in Fixed mode. In Simulator and Tables modes, a hardware current limit protection circuit turns the unit off when a programmable current limit is reached. This current limit is only programmable over the GPIB using SOUR:CURR:PROT.

Setting The OCP Protection

To activate overcurrent protection, press **OCP**. The **OCP** annunciator will light and Agilent SAS will continue to operate normally until it is forced into CC operation. If that occurs, the OCP circuit trips and the Agilent SAS output drops to zero.

Checking OCP Operation

The easiest way to check this operation at any specified current is to increase the load current beyond the programmed current value. This will force the Agilent SAS into the CC mode. When OCP trips, the **Prot** annunciator will light and the Agilent SAS output will drop to zero.

There is now no Agilent SAS output due to an overcurrent condition. To verify this, press **Protect** and observe that the display indicates **OC**.

Clearing The OCP Condition

With the OCP tripped, return to the meter mode and try to clear the condition by pressing **Prot Clear**. Nothing will appear to happen because the reason for the condition has not been removed. Thus, as soon as the circuit is cleared, it trips again. You can clear the OC condition by:

- Increasing the load resistance to lower the output current below the programmed current value, or
- By raising the programmed current to a value above that required by the load.

Clear the fault by either of the above methods. Then clear the OCP circuit by pressing **Prot Clear**. The **Prot** annunciator will go off and the Agilent SAS output will be restored to normal. If desired, you can also restore the output by disabling the OCP function (press **OCP** to turn off the **OCP** annunciator). This restores the output but does not clear any condition that may have caused OCP to trip.

Note Under certain conditions, the OCP circuit may fail to clear because load demand occurs before the Agilent SAS has time to build up the required output current capacity. In such cases, disable the output (press **Output On/Off**) before clearing the OCP circuit). After OCP is cleared, then enable the Agilent SAS output.

CV Mode VS. CC Mode

Once you program a voltage (V_{SET}) and a current (I_{SET}), the Agilent SAS will maintain itself in either CV or CC mode, depending on the resistance of the load (R_L). If the load demands less current than I_{SET} , operation will be in CV mode with the voltage maintained at V_{SET} . The output current will be at some value below I_{SET} as determined by $V_{SET} \div R_L$.

If the current increases beyond I_{SET} , the unit will switch to CC mode by varying its output voltage to maintain a constant current value of I_{SET} . As the load resistance is decreased, the voltage *decreases* to maintain the set current level. In other words, the output voltage is determined by $V_{SET} * R_L$.

Unregulated Operation

If the Agilent SAS goes into a mode of operation that is neither CV nor CC, the **Unr** annunciator will light. Some unregulated states occur so briefly that they do not turn on the **Unr** annunciator, but they may set the **UNR** status bit during remote operation (see chapter 6 under Programming Status). One condition that can cause a noticeable unregulated state is low ac line voltage. Another condition might be operation with a paralleled unit that has a different voltage setting.

Saving and Recalling Operating States

You can save programming time by storing up to five operating states in nonvolatile memory. The front panel programming parameters that are saved are:

- Output voltage Output current *OVP voltage.
 - OCP state (on or off) Output state (enabled or disabled).
-

Note More Agilent SAS parameters are saved in remote operation. See chapter 7 under *SAV.

As an example, set up the following state:

- Voltage = 4 V Current = 5 A OVP voltage = 4.5 V.
- OCP = on (**OCP** annunciator on) Output = off (**Dis** annunciator on).

Save the above state to location 1 by pressing **Save** **1** **Enter**. Now set up the following state:

- Voltage = 4.5 V Current = 2.5 A OVP voltage = 5 V.
- OCP = off (**OCP** annunciator off) Output = on (**Dis** annunciator off).

Save the above state to location 2 by pressing **Save** **2** **Enter**.

Restore the first state by pressing **Recall** **1** **Enter** and verify the parameters. Restore the second state by pressing **Recall** **2** **Enter**. Note how the Agilent SAS is automatically programmed each time.

Turn-On Conditions

Whenever you first apply power to an Agilent SAS it automatically turns on in a safe reset state, in Fixed mode, with the following parameters:

Output On/Off off **Voltage** 0 **Current** minimum*
OVP maximum **OCP** off

*Minimum is the *RST value specified in Table 7-3.

It is recommended that you leave the turn-on conditions as programmed. However, you may change them if you wish. To do this, proceed as follows:

1. Set up the Agilent SAS to the state you want when it is turned on.
2. Store that state to location 0.

3. Turn off the Agilent SAS.
4. Hold in the **8** key and turn the Agilent SAS back on. The display indicates **RCL 0 PWR-ON** to verify that the Agilent SAS has configured its turn-on state to that stored in location 0.
5. From now on the unit will always turn on to the state defined in location 0.

Whenever you wish, you can return the Agilent SAS to the original factory reset state. To do this, simply hold down the **9** key when you turn on the unit. The display indicates **RST POWER-ON** to verify that the Agilent SAS has configured its turn-on state to the original reset state. From now on it will continue to turn on in that state.

Setting The GPIB Address

Types of GPIB Addresses

Figure 4-11 in chapter 4 shows the ways the Agilent SAS can be connected to the GPIB bus. You can set up the GPIB address in one of three ways:

1. As a stand-alone unit (the only unit at the address). It has a primary address in the range of 0 to 30. For example: **5** or **7**.
2. As the direct unit in a serial link. It is the only unit connected directly to the GPIB bus. The primary address is unique and can be from 0 to 30. It is entered as an integer followed by a decimal separator. The secondary address always is 0, which may be added after the primary address. If the secondary address is omitted, it is assumed to be 0. For example: **5.0** or **7**.
3. As a linked unit in serial link. It gets its primary address from the direct unit. It has a unique secondary address that can be from 1 to 15. It is entered as an integer preceded by a decimal separator. For example: **.1** or **.12**

When you enter a secondary address, leading zeros between the decimal separator and the first digit are ignored. For example, **.1**, **.01**, and **.001** are accepted as secondary address 1 and displayed as **0.01**. Zeros following a digit are not ignored. Thus, **.10** and **.010** are both accepted as secondary address 10 and displayed as **0.10**.

Changing the GPIB Address

Use the **Address** key and numerical keypad for entering addresses. The Agilent SAS is shipped with a 5 stand-alone address as the default. The general procedure for setting an address is:

Action	Display Shows
Press Address	Current address
Press new address keys	New address replaces numbers on the display
Press Enter	Display returns to meter mode

If you try to enter an invalid number, **ADDR ERROR** is displayed.

The following examples show how to set addresses:

To set stand-alone primary address **6**, press **Address** **6** **Enter**.

To set direct unit primary address **6**, press **Address** **6** **.** **Enter**.

To set linked secondary address **1**, press **Address** **.** **1** **Enter**.

To set linked secondary address **12**, press **Address** **.** **1** **2** **Enter**.

Note The Agilent SAS display will reset (recall the state in location 0) whenever you change between a stand-alone primary address and a direct primary address, or a direct primary address and a secondary address.

Remote Programming

GPIB Capabilities of the Agilent SAS

All Agilent SAS functions except for setting the GPIB address are programmable over the IEEE 488 bus (also known as the General Purpose Interface Bus or "GPIB"). The IEEE 488.1 capabilities of the Agilent SAS are listed in the Supplemental Characteristics in appendix A. The Agilent SAS operates from a GPIB address that is set from the front panel (see System Considerations at the end of this chapter).

Introduction To SCPI

Important Learn the basics of Agilent SAS operation (see chapter 5 - Front Panel Operation) before using SCPI.

SCPI (Standard Commands for Programmable Instruments) is a programming language for controlling instrument functions over the GPIB (IEEE 488) instrument bus. SCPI is intended to function with standard GPIB hardware and conforms to the IEEE Standard Digital Interface for Programmable Instrumentation. SCPI is layered on top of the hardware portion of IEEE 488.2. The same SCPI commands and parameters control the same functions in different classes of instruments. For example, you would use the same DISPLAY command to control the Agilent SAS display state and the display state of a SCPI-compatible multimeter.

Note TMSL (Test and Measurement System Language) was an earlier versions of SCPI. If you have programmed in this language, then you probably can go directly to chapter 7 - Language Dictionary.

Conventions

The following conventions are used throughout this chapter:

Angle brackets	< >	Items within angle brackets are parameter abbreviations. For example, <NR1> indicates a specific form of numerical data.
Vertical bar		Vertical bars separate one of two or more alternative parameters. For example, 0 OFF indicates that you may enter either "0" or "OFF" for the required parameter.
Square Brackets	[]	Items within square brackets are optional. The representation [SOURce]:CURRent means that SOURce may be omitted.
Braces	{ }	Braces indicate parameters that may be repeated zero or more times. It is used especially for showing arrays. The notation <A>{<,B>} shows that "A" is a required parameter, while "B" may be omitted or may be entered one or more times.
Boldface font		Boldface font is used to emphasize syntax in command definitions. TRIGger:DELay <NRf> shows a command syntax.
Computer font		Computer font is used to show program text within normal text. TRIGger:DELay .5 represents program text.

Types of SCPI Commands

SCPI has two types of commands, common and subsystem.

- *Common* commands (see table 7-1) generally are not related to specific operation but to controlling overall Agilent SAS functions, such as reset, status, and synchronization. All common commands consist of a three-letter mnemonic preceded by an asterisk: ***RST *IDN? *SRE 8**
- Subsystem commands (see table 7-2) perform specific Agilent SAS functions. They are organized into an inverted tree structure with the "root" at the top. The following figure shows a portion of a subsystem command tree, from which you access the commands located along the various paths.

Figure 6-1 shows a portion of the subsystem command tree (you can see the complete tree in table 7-2). Note the location of the ROOT node at the top of the tree. The SCPI interface is at this location when:

- The Agilent SAS is powered on.
- A device clear (DCL) is sent to the Agilent SAS.
- The interface encounters a message terminator.
- The interface encounters a root specifier.

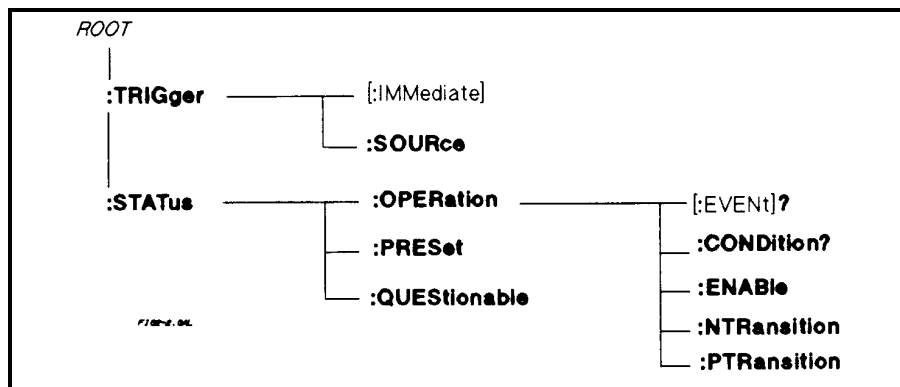

Figure 6-1. Partial Command Tree

Multiple Commands in a Message

Multiple SCPI commands can be combined and sent as a single message with one message terminator. There are two important considerations when sending several commands within a single message:

- Use a semicolon to separate commands within a message.
- There is an implied header path that affects how commands are interpreted by the Agilent SAS.

The header path can be thought of as a string that gets inserted **before** each command within a message. For the first command in a message, the header path is a null string. For each subsequent command the header path is defined as the characters that make up the headers of the previous command in the message up to and including the last colon separator. An example of a message with two commands is:

CURR:LEV 3;PROT:STAT OFF

which shows the use of the semicolon separating the two commands, and also illustrates the header path concept. Note that with the second command, the leading header "CURR" was omitted because after the "CURR:LEV 3" command, the header path was became defined as "CURR" and thus the instrument interpreted the second command as:

CURR:PROT:STAT OFF

In fact, it would have been syntactically incorrect to include the "CURR" explicitly in the second command, since the result after combining it with the header path would be:

CURR:CURR:PROT:STAT OFF

which is incorrect.

Moving Among Subsystems

In order to combine commands from different subsystems, you need to be able to restore the active path to the root. You do this with the root specifier (:). For example, you could clear the output protection and check the status of the Operation Condition register as follows:

```
OUTPUT:PROTECTION:CLEAR
STATUS:OPERATION:CONDITION?
```

By using the root specifier, you could do the same thing in one message (see figure 6-2):

```
OUTPUT:PROTECTION:CLEAR::STATUS:OPERATION:CONDITION?
```

The following message shows how to combine commands from different subsystems as well as within the same subsystem (see figure 6-2):

```
VOLTAGE:LEVEL 60;PROTECTION 65::CURRENT:LEVEL 4;PROTECTION ON
```

Note the use of the optional header **LEVEL** to maintain the correct path within the voltage and current subsystems and the use of the root specifier to move between subsystems.

Value Coupling

Value coupling results when a command directed to send one parameter also changes the value of a second parameter. There is no direct coupling among any Agilent SAS SCPI commands. However, be aware that until they are programmed, uninitialized trigger levels will assume their corresponding immediate levels. For example, if a unit is powered up and VOLT:LEV is programmed to 60, then VOLT:LEV:TRIG will also be 60 until you program it to another value. Once you program VOLT:LEV:TRIG to another value, it will remain at that value regardless of how you subsequently reprogram VOLT:LEVEL.

Including Common Commands

You can combine common commands with system commands in the same message. Treat the common command as a message unit by separating it with the message unit separator. Common commands *do not affect the active header path*; you may insert them anywhere in the message.

```
VOLT:TRIG 55;INIT;*TRG
OUTP OFF;*RCL 2;OUTP ON
```

SCPI Queries

Observe the following precautions with queries:

- Remember to set up the proper number of variables for the returned data.
- Set the program to read back all the results of a query before sending another command to the Agilent SAS. Otherwise, a *Query Interrupted* error will occur and the unreturned data will be lost.

Types of SCPI Messages

There are two types of SCPI messages, program and response.

- A *program message* consists of one or more properly formatted SCPI commands sent from the controller to the Agilent SAS. The message, which may be sent at any time, requests the Agilent SAS to perform some action.
- A *response message* consists of data in a specific SCPI format sent from the Agilent SAS to the controller. The Agilent SAS sends the message only when commanded by a special program message called a "query."

The following figure illustrates the SCPI message structure:

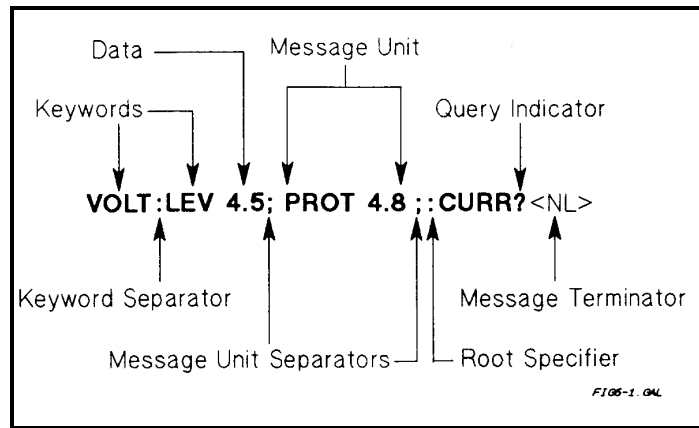

Figure 6-2. Command Message Structure

The Message Unit

The simplest SCPI command is a single message unit consisting of a command header (or keyword) followed by a message terminator. The message unit may include a parameter after the header. The parameter can be numeric or a string.

```
ABOR<NL>
VOLT 20<NL>
```

Headers

Headers (which are sometimes known as "keywords") are instructions recognized by the programming interface. Headers may be either in the long form or the short form.

Long Form The header is completely spelled out, such as `VOLTAGE STATUS DELAY`.

Short Form The header has only the first three or four letters, such as `VOLT STAT DEL`.

Query Indicator

Following a header with a question mark turns it into a query (`VOLT?` `VOLT:PROT?`). If a query contains a parameter, place the query indicator at the end of the last header (`VOLT:PROT? MAX`).

Message Unit Separator

When two or more message units are combined into a compound message, separate the units with a semicolon (`STATus:OPERation?;QUESTIONable?`).

Root Specifier

When it precedes the first header of a message unit, the colon becomes a "root specifier". This indicates that the command path is at the root or top node of the command tree.

Message Terminator

A terminator informs SCPI that it has reached the end of a message. Three permitted messages terminators are:

- Newline (`<NL>`), which is ASCII decimal 10 or hex 0A.
- End or identify (`<END>`)
- Both of the above (`<NL><END>`)

In the examples of this manual, there is an assumed message terminator at the end of each message. If the terminator needs to be shown, it is indicated as `<NL>` regardless of the actual terminator character.

SCPI Data Formats

All data programmed to or returned from the unit is ASCII. The data may be *numerical* or *character string*.

Numerical Data

Table 2-1. Numerical Data Formats

Symbol	Data Form
	Talking Formats
<NR1>	Digits with an implied decimal point assumed at the right of the least-significant digit. Examples: 273 0273
<NR2>	Digits with an explicit decimal point. Example: 273. 0273
<NR3>	Digits with an explicit decimal point and an exponent. Example: 2.73E+2 273.0E-2
	Listening Formats
<NRf>	Extended format that includes <NR1>, <NR2> and <NR3>. Examples: 273 273. 2.73E2
<NRf+>	Expanded decimal format that includes <NRf>, MIN and MAX . Examples: 273 273. 2.73E2 MAX. MIN and MAX are the minimum and maximum limit values that are implicit in the range specification for the parameter.
<Bool>	Boolean data. Either form 0 1 or OFF ON may be sent with commands. Queries always return a 0 or 1.

Suffixes and Multipliers

Some SCPI commands let you send engineering units as suffixes to extend numeric parameters. The following table lists the allowable suffixes and multipliers.

Table 2-2. Suffixes and Multipliers

Class	Suffix	Unit	Unit with Multiplier
Current	A	Ampere	MA (milliampere)
Amplitude	V	Volt	MV (millivolt)
Time	S	second	MS (millisecond)
	Common Multipliers		
	IE3	K	kilo
	1E-3	M	milli
	1E-6	U	micro

Character Data

For query statements, character strings may be returned in either of the forms shown in table 2-3, depending on the length of the returned string.

- <CRD> Character Response Data. Permits the return of character strings.
- <AARD> Arbitrary ASCII Response Data. Permits the return of un delimited 7-bit ASCII. This data type has an implied message terminator.
- <SRD> String Response Data. Returns string parameters enclosed in double quotes.

Examples

Most examples given here are generic, without regard to the programming language or type of GPIB interface. Because SCPI commands are sent as ASCII output strings within the programming language statements, the SCPI syntax is independent of both programming language and interface. The examples are followed by sample program code written for an Agilent BASIC controlled GPIB interface.

Programming Voltage and Current

Note The Agilent SAS responds simultaneously to both digital and analog programming inputs. If it is receiving an input over the GPIB and a corresponding input from the front panel (and from the analog programming port), the output will be the algebraic sum of the inputs. (Analog programming applies in Fixed mode only.)

The following statements program both voltage and current and return the actual output from the sense terminals:

OUTP OFF	<i>Disable the output.</i>
VOLT 55;CURR 2.5	<i>Program the voltage and current.</i>
VOLT?;CURR?	<i>Read back the programmed levels.</i>
OUTP ON	<i>Enable the output.</i>
MEAS:VOLT?;MEAS:CURR?	<i>Read back the outputs from the sense terminals.</i>

Programming Protection Circuits

This example programs the voltage and current, programs an overvoltage protection value, and turns on the overcurrent protection. It then reads back all the programmed values. Note the required use of the optional LEVel header in this example (see "Moving Among Subsystems" for more information).

VOLT:LEV 55;PROT 60	<i>Program the voltage and overvoltage protection.</i>
CURR:LEV 3;PROT:STAT ON	<i>Program the current and overcurrent protection.</i>
VOLT:LEV?;PROT?;CURR:LEV?;PROT:STAT?	<i>Read back the programmed values.</i>

Programming Units in Auto-Parallel

CAUTION Refer to "Auto-Parallel Programming Cautions" in chapter 4 before using Agilent SAS units in auto-parallel mode.

The following examples illustrate how to program a master unit and a slave unit that are connected in auto-parallel mode. The master unit is at address 705; the slave unit is at address 706. Refer to chapter 4 for connection information. Refer to chapter 7 for details about specific programming commands. The first example illustrates auto-parallel operation in Simulator mode.

1000 ! 2 Units in auto-parallel - Simulator Mode	
1010 OUTPUT 705;"*RST"	<i>Resets the master unit.</i>
1020 OUTPUT 706;"*RST"	<i>Resets the slave unit.</i>
1030 OUTPUT 705;"CURR:SAS:ISC 4;IMP 3;VOLT:SAS:VOC 60;VMP 40"	<i>Program curve data for master unit</i>
1040 OUTPUT 706;"CURR:SAS:ISC 0;IMP 0;VOLT:SAS:VOC 60;VMP 40"	<i>Program curve data for slave unit</i>
1050 OUTPUT 705;"CURR:MODE:SAS"	<i>Selects simulator mode for master unit.</i>
1060 OUTPUT 706;"CURR:MODE:SAS"	<i>Selects simulator mode for slave unit</i>
1070 OUTPUT 705;"OUTP:STAT ON"	<i>Enables the output for master unit.</i>
1080 OUTPUT 706;"OUTP:STAT ON"	<i>Enables the output for slave unit.</i>

The following example illustrates auto-parallel operation in Table mode.

1000 ! 2 Units in auto-parallel - Table Mode	
1010 OUTPUT 705;"*RST"	<i>Resets the master unit.</i>
1020 OUTPUT 706;"*RST"	<i>Resets the slave unit.</i>
1030 OUTPUT 705;"MEM:TABL:SEL TABLE1"	<i>Selects a table for entering data for master unit</i>
1040 OUTPUT 705;"MEM:TABL:VOLT 0, 5, 10, 50, 55, 60"	<i>Enter voltage data for master unit</i>
1050 OUTPUT 705;"MEM:TABL:CURR 4, 4, 3.5, 3, 2.5, 0"	<i>Enter current data for master unit</i>
1060 OUTPUT 705;"CURR:TABL:NAME TABLE1"	<i>Activates the table for master unit</i>
1070 OUTPUT 706;"MEM:TABL:SEL TABLE1"	<i>Selects a table for entering data for slave unit</i>
1080 OUTPUT 706;"MEM:TABL:VOLT 0, 5, 10, 50, 55, 60, 999"	<i>Enter voltage data for slave unit</i>
1090 OUTPUT 706;"MEM:TABL:CURR 4, 4, 3.5, 3, 2.5, 0, -999"	<i>Enter current data for slave unit</i>
1060 OUTPUT 706;"CURR:TABL:NAME TABLE1"	<i>Activates the table for slave unit</i>
1100 OUTPUT 705;"CURR:MODE:TABL::OUTP:STAT ON"	<i>Enables the output for master unit.</i>
1110 OUTPUT 706;"CURR:MODE:TABL::OUTP:STAT ON"	<i>Enables the output for slave unit.</i>

Changing Outputs by Trigger (applies in Fixed mode only)

If you do not program pending triggered levels, they default to the programmed (immediate) output levels. The following statements shows some basic trigger commands.

OUTP OFF	<i>Disable the output.</i>
VOLT:LEV:IMM 55;TRIG 60	<i>Program the voltage to 55V and the triggered level to 60 V.</i>
CURR:LEV:IMM 2.5;TRIG 3	<i>Program the current to 2.5 A and the triggered level to 3 A.</i>
VOLT:LEV:IMM?;TRIG?;CURR:LEV:IMM?;TRIG?	<i>Check all the programmed values.</i>
OUTP ON	<i>Enable the output.</i>
MEAS:VOLT?;CURR?	<i>Read back the immediate levels from the sense terminals.</i>
INIT;TRIG	<i>Arm the trigger circuit and send a single trigger.</i>
INIT;*TRG	<i>Same as above, except using a common command.</i>
MEAS:VOLT?;CURR?	<i>Read back the triggered levels from the sense terminals.</i>

If you need to send two or more triggers, program the trigger circuit for continuous arming.

OUTP OFF	<i>Disable the output.</i>
VOLT:LEV:IMM 60;TRIG 55	<i>Program the voltage to 60 V and the triggered level to 55 V.</i>
INIT:CONT ON	<i>Program the trigger circuit for continuous arming.</i>
OUTP ON	<i>Enable the output to 60 V.</i>
TRIG	<i>Trigger the output voltage to 55 V.</i>
VOLT:TRIG 60;TRIG	<i>Set the pending trigger level to 60 V and send a single trigger.</i>
INIT:CONT OFF	<i>Remove the continuous trigger arming.</i>

Saving and Recalling States

You can remotely save and recall operating states. See *SAV and *RCL in chapter 7 for more information.

Note: When you turn the Agilent SAS on, it automatically retrieves the state stored in location 0. When a unit is shipped, this location contains the factory defaults (see *RST in chapter 7).

OUTP OFF;VOLT:LEV 6.5;PROT 6.8	<i>Program a desired operating state.</i>
CURR:LEV 335;PROT:STAT ON	
*SAV 2	<i>Save this state to location 2.</i>
*RCL 2	<i>(Later) recall this same state.</i>

Writing to the Display

You can include messages to the front panel LCD in your programs. The description of DISP:TEXT in chapter 7 shows the number and types of permitted display characters. In order to write to the display, you must first change it to text mode as shown in the following example:

DIS:MODE TEXT	<i>Switch display to text mode.</i>
RECALLED 2	<i>Write "Recalled 2" to the display.</i>
DIS:MODE NORM	<i>Return display to its normal mode.</i>

Programming Status

You can use status programming to make your program react to events within the Agilent SAS. Chapter 8 - Status Reporting explains the functions and bit configurations of all status registers. Refer to figure 8-1 in that chapter while examining the examples given here. Usually you will want the Agilent SAS to generate interrupts (assert SRQ) upon particular events. For this you must selectively enable the appropriate status register bits. The following examples allow the unit to assert SRQ under selected conditions.

STAT:OPER:ENAB 1280;PTR 1280;*SRE 128	<i>Assert SRQ when the unit switches between CV and CC modes.</i>
STAT:OPER:ENAB 1;PTR 1;NTR 1;*SRE 128	<i>Assert SRQ when the unit enters or leaves calibration mode.</i>
STAT:QUES 3;PTR 3;*SRE 128	<i>Assert SRQ when the unit goes into overvoltage or overcurrent.</i>
STAT:OPER:ENAB 1280;PTR 1280; :STAT:QUES 3;PTR 3;*SRE 136	<i>Assert SRQ under any event occurring in the operation or questionable registers.</i>

The following example illustrates how you can exercise program control without interrupts by reading specific registers.

STAT:OPER:1280;EVEN?	<i>Enable only the CV and CC events and read their status.</i>
STAT:OPER:ENAB 1313;PTR 1313;EVEN?	<i>Enable all conditions of the Operation Status register and read any events.</i>
STAT:OPER:ENAB?;EVENT?;	<i>Read which events are active and which events are enabled in the</i>
:STAT:QUES:ENAB?;EVEN?;*ESE?;*ESR?	<i>Operation, Questionable, and Standard Event status registers.</i>

Note The last query string can be handled without difficulty. However, should you request too many queries, the system may return a "Query DEADLOCKED" error (-430). In that case, break the long string into smaller parts.

Programming the Digital I/O Port

Digital control ports 1 and 2 are TTL outputs that can be programmed either high or low. Control port 3 can be programmed to be either a TTL input or a TTL output. Send a decimal parameter that translates into the desired straight binary code for these ports. (See DIG:DATA[:VAL] in chapter 7 for the port bit configurations.)

DIG:DATA 3	<i>Set ports 1 and 2 high and make 3 another output port.</i>
DIG:DATA 7	<i>Set ports 1 and 2 high and make 3 an input port.</i>
DIG:DATA?	<i>Read back the present port configuration.</i>

System Considerations

The remainder of this chapter addresses some system issues concerning programming. These are addressing and the use of the following types of GPIB system interfaces:

1. HP Vectra PC controller with Agilent 82335A GPIB Interface Command Library.
2. IBM PC controller with National Instruments GPIB-PCII Interface/Handler.
3. Agilent controller with Agilent BASIC Language System.

The example program at the end of this chapter is intended to show how some of the same Agilent SAS functions can be programmed for the Agilent BASIC interface.

Assigning the GPIB Address In Programs

The Agilent SAS address cannot be set remotely; it must be set from the front panel. Once the address is set, you can assign it inside programs. Refer to chapter 5 under "Setting the GPIB Address" for more information. The following example assumes that the GPIB select code is 7, the primary address is 6, and that the Agilent SAS address will be assigned to the variable @PS.

```
1000 !Stand-alone address. The unit will respond if it is set to 6
1010 PS=706 ! Statement for Agilent 82335A Interface
1010 ASSIGN @PS TO 706 ! Statement for Agilent BASIC Interface
1020 !Direct address. The unit will respond if it is set to 6. or 6.0
1030 PS=70600 ! Statement for Agilent 82335A Interface
1030 ASSIGN @PS TO 70600 ! Statement for Agilent BASIC Interface
1040 !Linked address 1. The unit responds if it is set to address .1 and is serially connected to a unit at direct address 6.0
1050 PS=706.01 ! Agilent 82335A Interface
1090 ASSIGN @PS TO 706.01 ! Agilent BASIC Interface
```

For systems using the National Instruments DOS driver, the address is specified in the software configuration program (IBCONFIG.EXE) and assigned a symbolic name. The address then is referenced only by this name within the application program (see the National Instruments GP-IB documentation).

Agilent 82335A Driver Considerations

For GW-BASIC programming, the GPIB library is implemented as a series of subroutine calls. To access these subroutines, your application program must include the header file SETUP.BAS, which is part of the DOS driver software.

SETUP.BAS starts at program line 5 and can run up to line 999. Your application programs must begin at line 1000. SETUP.BAS has built-in error checking routines that provide a method to check for GPIB errors during program execution. You can use the error-trapping code in these routines or write your own code using the same variables as used by SETUP.BAS. If there is no error-handling code in your program, undetected errors can cause unpredictable results.

National Instruments GP-IB Driver Considerations

Your program must include the National Instruments header file DECL.BAS. This contains the initialization code for the interface. Prior to running any applications programs, you must set up the interface with the configuration program (IBCONF.EXE).

Your application program will not include the unit's symbolic name and GPIB address. These must be specified during configuration (when you run IBCONF.EXE). Note that the primary address range is from 0 to 30 but any secondary address must be specified in the address range of 96 to 126. The Agilent SAS expects a message termination on EOI or line feed, so set *EOI w/last byte of Write*. It is also recommended that you set *Disable Auto Serial Polling*.

All function calls return the status word *IBSTA%*, which contains a bit (ERR) that is set if the call results in an error. When ERR is set, an appropriate code is placed in variable *IBERR%*. Be sure to check *IBSTA%* after every function call. If it is not equal to zero, branch to an error handler that reads *IBERR%* to extract the specific error. If there is no error-handling code in your program, undetected errors can cause unpredictable results.

BASIC Considerations

The Agilent BASIC Programming Language provides access to GPIB functions at the operating system level. This makes it unnecessary to have the header files required in front of DOS applications programs. Also, you do not have to be concerned about controller "hangups" as long as your program includes a timeout statement. Because the Agilent SAS can be programmed to generate SRQ on errors, your program can use an SRQ service routine for decoding detected errors. The detectable errors are listed in appendix D.

SAMPLE PROGRAM FOR Agilent SAS USING THE AGILENT BASIC PROGRAMMING LANGUAGE

```

10!RE-STORE"SAS_DEMO"
20  !
30  ! This example program demonstrates how to:
40  !   1) use the Agilent SAS in Fixed Mode
50  !   2) use the Agilent SAS in Simulator Mode
60  !   3) use the Agilent SAS in Table Mode
70  ! This program assumes the Agilent SAS is at GPIB address 5
80  !=====
90  ! Resetting the Agilent SAS
100 !=====
110 CLEAR 705
120 OUTPUT 705;"*RST;*CLS"
130  !
140 ! Turn on the output with 5V and 1A current limit
150 Display_msg("FIXED MODE")
160 OUTPUT 705;"VOLT 5;;CURR 1"
170 Output_on
180  !
190 ! Set up and trigger a voltage change
200 OUTPUT 705;"VOLT:TRIG 6"    ! set trigger output level
210 OUTPUT 705;"INIT"         ! *** initiate trigger system ***
220 WAIT 2
230 OUTPUT 705;"TRIG"
240 WAIT 2
250  !
260 Output_off
270  !
280 ! Output a Simulator curve
290 Display_msg("SAS MODE")
300 OUTPUT 705;"CURR:SAS:ISC 4;IMP 3;;VOLT:SAS:VMP 40;VOC 55"
310 OUTPUT 705;"CURR:MODE SAS" ! put in Simulator mode
320 Output_on
330 WAIT 2
340 ! change the current curve to an auto-parallel "Slave" curve
350 OUTPUT 705;"CURR:SAS:ISC 0;IMP 0"
360 WAIT 2
370 Output_off
380  !
390 ! Table mode
400 Display_msg("TABLE MODE")
410  !
420 OUTPUT 705;"MEM:TABL:SEL T1" ! create table T1
430 ! Download data points for table T1
440 OUTPUT 705;"MEM:TABL:VOLT 0, 5, 10, 40, 45, 50"
450 OUTPUT 705;"MEM:TABL:CURR 4, 3.8, 3.6, 3, 1, 0"
460  !
470 OUTPUT 705;"CURR:TABL:NAME T1" ! activate table T1
480 OUTPUT 705;"CURR:MODE TABLE" ! put in Table mode
490 Output_on
500 WAIT 2
510 ! change voltage offset
520 OUTPUT 705;"VOLT:TABL:OFFS -2.25"
530 WAIT 2
540 ! change current offset
550 OUTPUT 705;"CURR:TABL:OFFS -0.5"
560 WAIT 2

```

Figure 6-3. Programming Agilent SAS Functions

```

570 ! delete table T1
580 Display_msg("DELETING T1")
590 Output_off
600 OUTPUT 705;"CURR:MODE FIX"      ! exit Table mode
610 OUTPUT 705;"CURR:TABL:NAME "   ! de-activate active table (T1)
620                                ! space required after :NAME
630 OUTPUT 705;"MEM:TABL:SEL  "    ! de-select working table (T1)
640                                ! space required after :SEL
650 OUTPUT 705;"MEM:DEL T1"       ! delete table T1
660 END
670 !
680 SUB Display_msg(Msg$)
690 OUTPUT 705;"DISP:TEXT  '&Msg$&' "
700 OUTPUT 705;"DISP:MODE TEXT"
710 WAIT 2
720 OUTPUT 705;"DISP:MODE NORM"
730 SUBEND
740 !
750 SUB Output_on
760 OUTPUT 705;"OUTP 1"
770 SUBEND
780 !
790 SUB Output_off
800 OUTPUT 705;"OUTP 0"
810 SUBEND
820 !

```

Figure 6-3. Programming Agilent SAS Functions (continued)

Language Dictionary

Introduction

This section gives the syntax and parameters for all the IEEE 488.2 SCPI commands and the Common commands used by the Agilent SAS. It is assumed that you are familiar with the material in chapter 6 - Remote Programming. That chapter explains the terms, symbols, and syntactical structures used here and gives an introduction to programming. You should also be familiar with chapter 5 - Front Panel Operation in order to understand how the Agilent SAS functions.

The programming examples are simple applications of SCPI commands. Since SCPI syntax remains the same for all programming languages, the examples are generic.

Syntax definitions use the long form, but only short form headers (or "keywords") appear in the examples. If you have any concern that the meaning of a header in your program listing will not be obvious at some later time, then use the long form to help make your program self-documenting.

Parameters

Most commands require a parameter and all queries will return a parameter. The range for a parameter may vary according to the model of Agilent SAS. Parameters for all models are listed in Table 7-3.

Related Commands

Where appropriate, related commands or queries are included. These are listed either because they are directly related by function or because reading about them will clarify or enhance your understanding of the original command or query.

Order of Presentation

The dictionary is organized as follows:

- IEEE 488.2 common commands, in alphabetical order.
- Subsystem commands.

Common Commands

Common commands begin with an * and consist of three letters (command) or three letters and a ? (query). *Common* commands are defined by the IEEE 488.2 standard to perform some common interface functions. The Agilent SAS responds to the 13 required common commands that control status reporting, synchronization, and internal operations. The Agilent SAS also responds to five optional common commands controlling triggers, power-on conditions, and stored operating parameters.

Subsystem Commands

Subsystem commands are specific to Agilent SAS functions. They can be a single command or a group of commands. The groups are comprised of commands that extend one or more levels below the root. The description of subsystem commands follows the listing of the common commands.

Description Of Common Commands

Table 7-1 shows the common commands and queries. These commands are listed alphabetically in the dictionary. If a command has a corresponding query that simply returns the data or status specified by the command, then both command and query are included under the explanation for the command. If a query does not have a corresponding command or is functionally different from the command, then the query is listed separately. The description of each common command or query specifies any status registers affected. In order to make use of this information, you must refer to "Chapter 4 - Status Reporting", which explains how to read specific register bits and use the information that they return.

Table 7-1 Common Commands

Command	Parameters	Command	Parameters	Command	Parameters
*CLS	(None)	*OPC?	(None)	*SRE	<NRF>
*ESE	<NRF>	*PSC	<bool>	*SRE?	(None)
*ESE?	(None)	*PSC?	(None)	*STB?	(None)
*ESR?	(None)	*RCL	<NRF>	*TRG	(None)
*IDN?	(None)	*RST	(None)	*TST?	(None)
*OPC	(None)	*SAV	<NRF>	*WAI	(None)

*CLS

Meaning and Type

Clear Status Device Status

Description

This command causes the following actions (see "Chapter 4 - Status Reporting" for descriptions of all registers):

- Clears the Standard Event Status, Operation Status Event, Questionable Status Event, and Status Byte registers.
- Clears the Error Queue.
- If *CLS immediately follows a program message terminator (<NL>), then the output queue and the MAV bit are also cleared.

Command Syntax *CLS
Parameters (None)
Query Syntax (None)

*ESE

Meaning and Type

Event Status Enable Device Status

Description

This command programs the Standard Event Status Enable register bits. The programming determines which events of the Standard Event Status Event register (see *ESR?) are allowed to set the ESB (Event Summary Bit) of the Status Byte register. A "1" in the bit position enables the corresponding event. All of the enabled events of the Standard Event Status Event register are logically ORed to cause the Event Summary Bit (ESB) of the Status Byte register to be set. See chapter 4 - "Status Reporting" for descriptions of all three registers.

Bit Configuration of Standard Event Status Enable Register

Bit Position	7	6	5	4	3	2	1	0
Bit Name	PON	0	CME	EXE	DDE	QYE	0	OPC
Bit Weight	128	64	32	16	8	4	2	1
CME = Command error; DDE = Device-dependent error; EXE = Execution error; OPC = Operation complete; PON Power-on; QYE = Query error.								

CAUTION

If PSC is programmed to 0, the *ESE register bits are stored in nonvolatile memory. The nonvolatile memory has a finite maximum number of write cycles (see Supplemental Characteristics in appendix A). Programs that repeatedly write to nonvolatile memory can eventually exceed the maximum number of write cycles and may cause the memory to fail.

Command Syntax	*ESE <NRf>
Parameters	0 to 255
Power On Value	(See *PSC)
Suffix	(None)
Example	*ESE 129
Query Syntax	*ESE?
Returned Parameters	<NR1> (Register value)
Related Commands	*ESR? *PSC *STB?

***ESR?**

Meaning and Type

Event Status Register Device Status

Description

This query reads the Standard Event Status Event register. Reading the register clears it. The bit configuration of this register is the same as the Standard Event Status Enable register (*ESE). See "Chapter 4 - Status Reporting" for a detailed explanation of this register.

Query Syntax	*ESR?
Parameters	(None)
Returned Parameters	<NR1> (Register binary value)
Related Commands	*CLS *ESE *ESE? *OPC

***IDN?**

Identification Query

Meaning and Type

Identification System Interface

Description

This query requests the Agilent SAS to identify itself. It returns a string composed of four fields separated by commas.

Query Syntax	*IDN?
Returned Parameters	<AARD>
	Field Information
	<i>Agilent Technologies</i> Manufacturer
	EnnnnB 6-character model number
	USnnnnnnnn 10-character serial number or 0
	<R>.xx.xx Revision levels of firmware
Example	AGILENT TECHNOLOGIES ,E4350B,0,A.00.01
Related Commands	(None)

*OPC

Meaning and Type

Operation Complete Device Status

Description

This command causes the interface to set the OPC bit (bit 0) of the Standard Event Status register when the Agilent SAS has completed all pending operations. (See *ESE for the bit configuration of the Standard Event Status register.) *Pending operations* are complete when:

- All commands sent before *OPC have been executed. This includes overlapped commands. Most commands are sequential and are completed before the next command is executed. Overlapped commands are executed in parallel with other commands. Commands that affect output voltage, current or state, relays, and trigger actions are overlapped with subsequent commands sent to the Agilent SAS.
- Any change in the output level caused by previous commands has been completed.
- All triggers are completed.

*OPC does not prevent processing of subsequent commands but Bit 0 will not be set until all pending operations are completed.

Command Syntax	*OPC
Parameters	(None)
Query Syntax	(None)
Related Commands	*OPC? *ESE

*OPC?

Meaning and Type

Operation Complete Device Status

Description

This query causes the interface to place an ASCII "1" in the Output Queue when all pending operations are completed. *Pending operations* are as defined for the *OPC command. Unlike *OPC, *OPC? prevents processing of all subsequent commands. *OPC? is intended to be used at the end of a command line so that the application program can then monitor the bus for data until it receives the "1" from the power module Output Queue.

CAUTION

Do not follow *OPC? with *TRG or GPIB bus triggers. Since triggers sent after *OPC? will not execute, this will prevent the unit from accepting further commands. If this occurs, the only programmable way to restore operation is by sending the Agilent SAS a GPIB **DCL** (Device Clear).

Query Syntax	*OPC?
Returned Parameters	<NRI> A 1 is placed in the Output Queue when the operation is complete
Related Commands	*OPC *TRIG *WAI

*OPT?

Meaning and Type

Option Identification Query

Description

This query identifies any installed options. Options are identified by a number. 0 indicates no options are installed.

Query Syntax	*OPT?
Returned Parameters	<AARD> (multiple options separated by commas)

*PSC

Meaning and Type

Power-on Status Clear Device Initialization

Description

This command controls the automatic clearing at power turn-on of the Service Request Enable register and the Standard Event Status Enable register. The setting of the *PSC command is stored in non-volatile memory.

If the command parameter = 1, then the above registers are cleared at power turn-on. If the command parameter = 0, then the above registers are not cleared at power turn-on but are programmed to their last state prior to power turn on. This is the most common application for *PSC and enables the power module to generate an SRQ (Service Request) at power on.

CAUTION

*PSC writes to nonvolatile memory. If *PSC is programmed to 0, then the *ESE and *SRE commands also write to nonvolatile memory. The nonvolatile memory has a finite maximum number of write cycles (see Supplemental Characteristics in appendix A). Programs that repeatedly write to nonvolatile memory can eventually exceed the maximum number of write cycles and may cause the memory to fail.

Command Syntax	*PSC <bool>
Parameters	0 1 OFF ON
Example	*PSC 0 *PSC 1
Query Syntax	*PSC?
Returned Parameters	<NR1> 0 1
Related Commands	*ESE *SRE

*RCL

Meaning and Type

Recall Device State

WARNING

Recalling a previously stored state may place hazardous voltage at the Agilent SAS output.

Description

This command restores the Agilent SAS to a state that was previously stored in memory with a *SAV command to the specified location. The following states are recalled:

CURR[:LEV][:IMM]	DIG:DATA[:VAL]	VOLT[:LEV][:IMM]
CURR:PROT:STAT	OUTP[:STAT]	VOLT:PROT[:LEV]
CURR:PROT[:LEV]	OUTP:PROT:DEL	

Sending *RCL also does the following:

- Forces an ABORt command before resetting any parameters (this cancels any uncompleted trigger actions).
- Disables the calibration function by setting CAL:STATe to OFF.
- Sets display functions as follows:
 - [:WIND][:STATe] to ON.
 - [:WIND]:MODE to NORMal.
 - [:WIND]:TEXT to ' '.
- Sets INIT:CONT to OFF.
- Sets TRIG:SOUR to BUS.
- Resets the Agilent SAS to FIXed mode (CURR:MODE:FIX)

At power turn-on, the Agilent SAS normally is returned to the factory defined turn-on state (see *RST). However, it also may turn on to the state stored in location 0 (see chapter 5 under *Turn-On Condition*).

Command Syntax	*RCL <NRf>
Parameters	0 1 2 3
Example	*RCL 3
Query Syntax	(None)
Related Commands	*PSC *RST *SAV

*RST

Meaning and Type

Reset Device State

Description

This command resets the Agilent SAS to a factory-defined state as defined below. ***RST** also forces an **ABORT** command. If Simulator or Table mode had previously been programmed, the operation of the unit returns to Fixed mode. Simulator mode settings revert to the factory default values, and no tables are selected.

<u>Command</u>	<u>State</u>
CAL:STAT <i>OFF</i>	DISP[:WIND]:MODE <i>NORM</i>
CURR[:LEV][:IMM] *	DISP[:WIND]:TEXT
CURR[:LEV]:TRIG *	INIT:CONT <i>OFF</i>
CURR:MODE <i>FIXed</i>	OUTP[:STAT] <i>OFF</i>
CURR:PROT <i>MAX</i>	OUTP:PROT:DEL *
CURR:PROT[:LEV] *	TRIG:SOUR <i>BUS</i>
CURR:PROT:STAT <i>OFF</i>	VOLT[:LEV][:IMM] *
CURR:SAS:ISC <i>IMAX</i>	VOLT[:LEV][:TRIG] *
CURR:SAS:IMP <i>0.8 X IMAX</i>	VOLT:PROT[:LEV] *
CURR:TABL:OFFS <i>0</i>	VOLT:SAS:VOC <i>VMAX</i>
DIG:DATA <i>0</i>	VOLT:SAS:VMP <i>0.8 X VMAX</i>
DISP[:WIND]:STAT <i>ON</i>	VOLT:TABL:OFFS <i>0</i>

* Model-dependent value. See Table 7-3.

Command Syntax	*RST
Parameters	(None)
Query Syntax	(None)
Related Commands	*PSC *SAV

*SAV

Meaning and Type

SAVE Device State

Description

This command only applies in **Fixed** operating mode. It saves the present state of the Agilent SAS to the specified location in non-volatile memory. Up to four states can be stored. Under certain conditions (see Turn-On Conditions in chapter 5), location *0* may hold the device state that is automatically recalled at power turn-on. Simulator and Table mode states cannot be saved by this command. The following Agilent SAS parameters are stored by ***SAV**:

CURR[:LEV][:IMM]	OUTP[:STAT]	OUTP:REL:POL
CURR:PROT:STAT	OUTP:PROT:DEL	VOLT[:LEV][:IMM]
DIG:DATA[:VAL]	OUTP:REL[:STAT]	VOLT:PROT[:LEV]

CAUTION

The Agilent SAS uses nonvolatile memory for recording register states. Programs that repeatedly use ***SAV** for recalling states cause frequent write cycles to the memory and can eventually exceed the maximum number of write cycles and may cause the memory to fail (see Supplemental Characteristics in appendix A).

Command Syntax	*SAV <NRf>
Parameters	0 1 2 3
Example	SAV 3
Query Syntax	(None)
Related Commands	*RCL *RST

SRE*Meaning and Type**

Service Request Enable Device Interface

Description

This command sets the condition of the Service Request Enable Register. This register determines which bits from the Status Byte Register (see ***STB** for its bit configuration) are allowed to set the Master Status Summary (MSS) bit and the Request for Service (RQS) summary bit. A *1* in any Service Request Enable Register bit position enables the corresponding Status Byte Register bit and all such enabled bits then are logically ORed to cause Bit 6 of the Status Byte Register to be set. See "Chapter 4 - Status Reporting" for more details concerning this process.

When the controller conducts a serial poll in response to SRQ, the RQS bit is cleared, but the MSS bit is not. When ***SRE** is cleared (by programming it with *0*), the Agilent SAS cannot generate an SRQ to the controller.

CAUTION

If **PSC** is programmed to *0*, the ***SRE** register bits are stored in nonvolatile memory. The nonvolatile memory has a finite maximum number of write cycles (see Supplemental Characteristics in appendix A). Programs that repeatedly write to nonvolatile memory can eventually exceed the maximum number of write cycles and may cause the memory to fail.

Command Syntax	*SRE <NRf>
Parameters	0-to 255
Default Value	(See *PSC)
Example	*SRE 20
Query Syntax	*SRE?
Returned Parameters	<NR1> (Register binary value)
Related Commands	*ESE *ESR *PSC

STB?*Meaning and Type**

Status Byte Device Status

Description

This query reads the Status Byte register, which contains the status summary bits and the Output Queue MAV bit. Reading the Status Byte register does not clear it. The input summary bits are cleared when the appropriate event registers are read (see "Chapter 4 - Status Reporting" for more information). The MAV bit is cleared at power on or by ***CLS**.

A serial poll also returns the value of the Status Byte register, except that bit 6 returns a Request for Service (RQS) instead of a Master Status Summary (MSS). A serial poll clears RQS, but not MSS. When MSS is set, it indicates that the Agilent SAS has one or more reasons for requesting service.

Description Of Subsystem Commands

Table 7-2 is a tree diagram of the subsystem commands. Commands followed by a question mark (?) take only the query form. Except as noted in the syntax descriptions, all other commands take both the command and query form. The commands are listed in alphabetical order and the commands within each subsystem are grouped alphabetically under the subsystem.

This summary lists all Agilent SAS subsystem commands in alphabetical order, followed by all common commands in alphabetical order. See Table 7-3 for the command parameters accepted by each Agilent SAS model.

Table 7-2. Subsystem Commands Syntax

ABORt	Resets the trigger system to the Idle state
CALibrate	See Appendix B
DISPlay	
[:WINDow]	
[:STATe] <bool>	Enable/disable front panel display (0,1,OFF,ON)
:MODE <mode>	Set display mode (NORM TEXT)
:TEXT [:DATA] <string>	Sets the text that is displayed
INITiate	
[:IMMediate]	Initiates the output trigger system
:CONTInuous, <bool>	Sets continuous initialization (0,1,OFF,ON)
MEASure	
:CURRent [:DC]?	Returns dc current
:VOLTagE [:DC]?	Returns dc voltage
MEMory	
:COpy	
:TABLE <name>	Copy selected table to non-volatile memory with new name.
:DElete	
:ALL DElete <name>	Delete all user-defined tables
[:NAME] <name>	Delete specified user-defined table
:TABLE	
:CATalog?	Returns names of all user-defined tables
:CURRent	
[:MAGNitude] <NRf+>	Appends current points to selected table
:POINts?	Returns number of current points in selected table
:SElect [<name>]	Selects a table for subsequent table commands
:VOLTagE	
[:MAGNitude] <NRf+>	Appends voltage points to selected table
:POINts?	Returns number of voltage points in selected table
OUTPut	
[:STATe] <bool>	Enables/disables the dc source output
:PROTection	
:CLEar	Reset latched protection
:DElay <NRf+>	Delay after programming/before protection (0 to 32,767)

Table 7-2. Subsystem Commands Syntax (continued)

[SOURce:]	
CURRent	
[:LEVel]	
[:IMMediate][:AMPLitude]<NRf+>	Sets the output current level
:TRIGgered [:AMPLitude] <NRf+>	Sets the triggered output current level
:MODE <mode>	Sets the operating mode (FIX SAS TABL)
:PROTection	
[:LEVel] <NRf+>	Sets over-current protection level in Simulator and Table modes
:STATe <bool>	Enable/Disable Fixed mode current limit protection (0,1,OFF,ON).
:SASimulator	
:ISC <NRf+>	Sets the short-circuit current in simulator mode
:IMP <NRf+>	Sets the maximum-power current in simulator mode
:TABLe	
:NAME [<name>]	Selects a table for use when the operating mode is Table
:OFFSet <NRf+>	Sets the offset current when the operating mode is Table
DIGital	
:DATA [:VALue] <NRf+>	Sets and reads the digital control port
VOLTage	
[:LEVel]	
[:IMMediate][:AMPLitude] <NRf+>	Sets the dc voltage level
:TRIGgered [:AMPLitude] <NRf+>	Sets the triggered voltage level
:PROTection [:LEVel] <n>	Sets the overvoltage protection threshold
:SASimulator	
:VOC <NRf+>	Sets the open-circuit voltage in simulator mode
:VMP <NRf+>	Sets the maximum-power voltage in simulator mode
:TABLe	
:OFFSet <NRf+>	Sets the offset voltage when the operating mode is Table
STATus	
:OPERation	
[:EVENt]?	Returns the value of the event register
:CONDition?	Returns the value of the condition register
:ENABle <NRf>	Enables specific bits in the Event register
:NTRansition<NRf>	Sets the Negative transition filter
:PTRansition<NRf>	Sets the Positive transition filter
:PRESet	Presets all enable and transition registers to power-on
:QUESTionable	
[:EVENt]?	Returns the value of the event register
:CONDition?	Returns the value of the condition register
:ENABle <NRf>	Enables specific bits in the Event register
:NTRansition<NRf>	Sets the Negative transition filter
:PTRansition<NRf>	Sets the Positive transition filter
SYSTem	
:ERRor?	Returns the error number and error string
:VERsion?	Returns the SCPI version number
TRIGger	
[:IMMediate]	Triggers the measurement immediately
:SOURce <source>	Sets the trigger source (BUS)

Table 7-3 list the programming parameters for each of the models in Fixed mode

Table 7-3. Agilent SAS Programming Parameters (in Fixed Mode)

Parameter	Agilent E4350B	Agilent E4351B
CURR[:LEV] MAX and CURR[:LEV]:TRIG MAX CURR:PROT[:LEV]: MAX (Programming range is 0 to MAX)	8.16 A 8.16 A 10 A	4.08 A 4.08 A 5 A
*RST Current Value *RST Current Protect Value	0.096 A MAX for both models	0.048 A MAX for both models
OUTP:PROT:DEL *RST Value	0 to 32.767 s (MAX) both models 200 ms both models	
VOLT[:LEV] MAX and VOLT[:LEV]:TRIG MAX (Programming range is 0 to MAX)	61.50 V 61.50 V	123.0 V 123.0 V
*RST Voltage Value	0 V for both models	
VOLT:PROT MAX (Programming range is 0 to MAX)	73.0 V	140.0 V
*RST OVP value	73.0 V	140.0 V

Calibration Commands

See appendix B.

Display Subsystem

This subsystem controls the state and output of the alphanumeric portion of the display.

DISP

Enables or disables the display. When disabled, the display characters are blank. The annunciators are not affected by this command.

Command Syntax	DISPlay[:WINDow][:STATe] <bool>
Parameters	0 1 OFF ON
*RST Value	ON
Examples	DISP ON DISPLAY:STATE ON
Query Syntax	DISPlay[:WINDow][STATe]?
Returned Parameters	<NR1> 0 or 1
Related Commands	DISP:MODE DISP:TEXT *RST

DISP:MODE

Switches the display between its normal metering mode and a mode in which it displays text sent by the user.

Command Syntax	DISPlay[:WINDow]:MODE <CRD>
Parameters	NORMal TEXT
*RST Value	NORM
Examples	DISP:MODE NORM DISPLAY:MODE NORMAL
Query Syntax	DISPlay[:WINDow]:MODE?
Returned Parameters	<CRD> NORMAL or TEXT
Related Commands	DISP DISP:TEXT *RST

DISP:TEXT

Sends character strings to the display when the display mode is TEXT. The LCD display has the following character set:

LCD Character Set

uppercase letters	A through Z (Case-sensitive entry)
digits	0 through 9
punctuation	_ “ \$ < > + - / = ? . : ,
blank space	

A display is capable of showing up to 12 characters. However, the three punctuation characters do not count toward the 12-character limit when they are preceded by an alphanumeric character. When punctuation characters are included, then the maximum number of characters (alphanumeric + punctuation) that can be displayed is 15. If it exceeds the display capacity, a message will be truncated to fit and no error message will be generated. If any character in the message is not a member of the above character set, the character will be displayed as a starburst (all 16 segments of the character are lit).

Note *IEEE Standard Digital Interface* for Programmable Instrumentation requires that a string be enclosed in either single (') or double (") quotes.

Command Syntax	DISPlay[:WINDow]:TEXT [:DATA] <STR>
Parameters	(See LCD character set)
*RST Value	' '
Examples	DISP:TEXT "DEFAULT_MODE"
Query Syntax	DISPlay[:WINDow]:TEXT?
Returned Parameters	<STR> (Last programmed text string)
Related Commands	DISP DISP:MODE *RST

Measure Subsystem

Measurement commands measure the output voltage and current.

MEAS:CURRENT?

MEAS:VOLTAGE?

These queries return the voltage and current measured at the Agilent SAS's sense terminals.

Query Syntax	MEASure:CURREnt[:DC]?		
	MEASure:VOLTage[:DC]?		
Parameters	(None)		
Default Suffix	A for MEAS:CURRENT?		
	V for MEAS:VOLTAGE?		
Examples	MEAS:CURRENT? MEAS:VOLTAGE?	MEASURE:VOLTAGE:DC? MV	
Returned Parameters	<NR3>		

Memory Subsystem

This subsystem manages the instrument's data table memory.

MEM:COPY:TABL

This command copies the table that was selected with MEM:TABL:SEL to **non-volatile** memory. You can use the same name or a different name. Names cannot be longer than 12 alphanumeric characters and must start with an alpha character. A maximum of 30 tables can be stored in non-volatile memory. Non-volatile memory has only 3,500 table points available to be shared among all tables. Tables larger than 3,500 points cannot be copied.

Command Syntax	MEMory:COpy:TAble <STR>
Parameters	a valid table name
Examples	MEM:COpy:TAbl curve1

MEM:DEL:ALL MEM:DEL[:NAME]

These commands delete all, or the specified user-defined table in both volatile and non-volatile memory. Note that MEM:DEL:ALL does not delete any tables if a table has been activated with the SOURe:CURRent:TABLE command.

Command Syntax	MEMory:DELeTe:ALL MEMory:DELeTe[:NAME] <STR>
Parameters	a valid table name
Examples	MEM:DEL:ALL MEM:DEL:NAME curve1

MEM:TABL:SEL

This command creates a new table to be programmed with a list of voltage and current points. Table names cannot be longer than 12 alphanumeric characters and must start with an alpha character. This command is also used to select an existing table in volatile memory to be copied into non-volatile memory using MEM:COPY:TABL. If you send this command without specifying a table name, it will de-select any selected table.

Command Syntax	MEMory:TAble:SElect [<name>]
Parameters	a valid table name
Examples	MEM:TABL:SEL MEM:TABL:SEL curve1

MEM:TABL:CURR MEM:TABL:VOLT

These commands program a list of current or voltage points for a new table. A table must have at least 3 points. A maximum of 100 comma-separated points may be entered each time the commands are used. Repeatedly sending this command will append additional points to the end of the table, up to a maximum of 4000 points. A maximum of 30 tables can be stored in **volatile** memory. Volatile memory has 30,000 table points available to be shared among all tables.

If you are programming a slave unit that is paralleled to a master unit, you must send the same values to the slave unit. However, you must append a -999 to the end of the current string and a +999 to the end of the voltage string. These values configure the unit as a slave.

Command Syntax	MEMory:TAble:CURRent [:MAGNitude] <Nrf> MEMory:TAble:VOLTagE [:MAGNitude] <Nrf>
Parameters	0 to maximum current or voltage rating (current values must be entered in equal or in descending order; voltage values must be entered in ascending order)
Default Value	0
Examples	MEM:TABL:CURR 7.8,7.7,7.5, 7,6.5,5.5,4,3,2,1 MEM:TABL:CURR 7.8,7.7,7.5, 7,6.5,5.5,4,3,2,1, -999 (paralleled slave unit) MEM:TABL:VOLT 5,35,45,50,52,54,56,57,58,59 MEM:TABL:VOLT 5,35,45,50,52,54,56,57,58,59, +999 (paralleled slave unit)

MEM:TABL:CURR:POIN?
MEM:TABL:VOLT:POIN?

These commands return the number of current or voltage points in the active table.

Query Syntax	MEMory:TABLE:CURRent[:MAGnitude]:POINts? MEMory:TABLE:VOLTage[:MAGnitude]:POINts?
Returned Parameters	<NRI> (number of points)
Examples	MEM:TABL:CURR:POIN? MEM:TABL:VOLT:POIN?
Related Commands	MEM:TABL:VOLT MEM:TABL:CURR

MEM:TABL:CAT?

This command returns the names of all user-defined table.

Query Syntax	MEMory:TABLE:CATalog?
Returned Parameters	<STR> (all table names separated by commas)
Examples	MEM:TABL:CAT? "Table1", "Table2", "Table3", "" (" " = end of list)

Output Subsystem

Output commands control the Agilent SAS's voltage and current outputs and an optional output relay.

Source commands program the actual voltage, current, and protection functions.

OUTP

This command enables or disables the Agilent SAS output. The state of a disabled output is a condition of zero output voltage and a model-dependent minimum source current (see Table 7-3). The query form returns the output state.

Command Syntax	OUTPut[:STATe] <bool>
Parameters	0 OFF 1 ON
*RST Value	0
Examples	OUTP 1 OUTPUT:STATE ON
Query Syntax	OUTPut(:STATe)?
Returned Parameters	<NRI> 0 or 1
Related Commands	*RST *RCL *SAV

OUTP:PROT:CLE

This command clears any OV (overvoltage), OC (overcurrent), OT (overtemperature), or RI (remote inhibit) protection features. After this command, the output is restored to the state it was in before the protection feature occurred.

Command Syntax	OUTPut:PROTEction:CLEar
Parameters	(None)
Query Syntax	(None)
Examples	OUTP:PROT:CLE OUTPUT:PROTECTION:CLEAR

OUTP:PROT:DEL

This command only applies in Fixed mode. It sets the time in seconds between the programming of an output change that produces a CV, CC, or UNREG condition and the recording of that condition by the Status Operation Condition register. The delay prevents the momentary changes in Agilent SAS status that can occur during reprogramming from being registered as events by the status subsystem. Since the delay applies to CC status, it also delays the OCP (Fixed mode overcurrent protection) feature. The OVP (overvoltage protection) and the OC (overcurrent level) is not affected by this delay.

Command Syntax	OUTPut:PROTection:DELay <NRf>
Parameters	0 to 32,767 MIN MAX
Units	seconds
*RST Value	0
Examples	OUTPUT:PROTECTION:DELAY 75E-1
Query Syntax	OUTPut:PROTection:DELay? OUTPut:PROTection:DELay? MIN OUTPut:PROTection:DELay? MAX
Returned Parameters	<NR3> OUTP:PROT:DEL? returns value of programmed delay. OUTP:PROT:DEL? MIN and OUTP:PROT:DEL? MAX return the minimum and maximum programmable delays.
Related Commands	*RST *RCL *SAV CURR:PROT:STAT

[SOUR:]CURR [SOUR:]CURR:TRIG

These commands only apply in Fixed mode. They set the immediate current level or the pending triggered current level of the Agilent SAS. The immediate level is the current programmed for the output terminals. The pending triggered level is a stored current value that is transferred to the output terminals when a trigger occurs. A pending triggered level is unaffected by subsequent **CURR** commands and remains in effect until the trigger subsystem receives a trigger or an **ABORT** command is given. If there is no pending **CURR:TRIG** level, then the query form returns the **CURR** level. In order for **CURR:TRIG** to be executed, the trigger subsystem must be initiated (see **INITiate**).

Command Syntax	[SOURce]:CURRent[:LEVel] [:IMMediate][:AMPLitude] <NRf+> [SOURce][:CURRent[:LEVel]:TRIGgered [:AMPLitude] <NRf+>
Parameters	Table 7-3
Default Suffix	A
*RST Value	Table 7-3
Examples	CURR 200 MA CURRENT:LEVEL 200 MA CURR:TRIG 20 CURRENT:LEVEL:TRIGGERED 20
Query Syntax	[SOURce]:CURRent[:LEVel] [:IMMediate][:AMPLitude]? [SOURce]:CURRent[:LEVel] [:IMMediate][:AMPLitude]? MAX [SOURce]:CURRent[:LEVel] [:IMMediate][:AMPLitude]? MIN [SOURce]:CURRent[:LEVel]:TRIGgered [:AMPLitude]? [SOURce]:CURRent[:LEVel]:TRIGgered [:AMPLitude]? MAX [SOURce]:CURRent[:LEVel]:TRIGgered [:AMPLitude]? MIN
Returned Parameters	<NR3> CURR? and CURR:TRIG? return presently programmed immediate and triggered levels. If not triggered level is programmed, both returned values are the same. CURR? MAX and CURR? MIN return the maximum and minimum programmable immediate current levels. CURR:TRIG? MAX and CURR:TRIG? MIN return the maximum and minimum programmable triggered current levels.
Related Commands	For CURR *SAV *RCL *RST For CURR:TRIG ABOR CURR *RST

[SOUR:]CURREnt:MODE

This command selects the operating mode of the Agilent SAS. The choices are:

FIXed	In Fixed mode, the output is a fixed rectangular I-V characteristic. The output capacitance is <100 nF on the Agilent E4350B and <50 nF on the Agilent E4351B, which optimizes the unit as a constant current source. To use the unit as a low-impedance constant voltage source, you can add an external output capacitor if desired, the value of which should not exceed 2,000 µF. Fixed mode is the power-on default mode.
SASimulator	Simulator mode uses an exponential model to approximate the I-V curve. It is programmed in terms of its open circuit voltage (Voc), short circuit current (Isc), voltage point (Vmp), and current point (Imp) at approximately the peak power point. All of these parameters are set using separate SCPI commands (see chapter 1 for more information about Simulator mode).
TABLE	Table mode sets the output characteristics by a user-defined table of voltage/current points. A curve is generated by connecting the points by straight lines. Therefore, the more points that are provided, the more the connected points will resemble a curve.

Maximum number of tables:	30 volatile and 30 nonvolatile
Maximum table size (per table)	4,000 points
Maximum non-volatile table points available for all tables	3,500 points
Maximum volatile table points available for all tables	30,000 points

Tables are programmed using the MEMory commands as previously discussed.

Command Syntax	[SOURce]:CURREnt:MODE <mode>
Parameter	FIXed SASimulator TABLE
*RST Value	FIXed
Examples	CURR:MODE TABL
Query Syntax	CURR:MODE?
Returned Parameters	<CRD>

[SOUR:]CURR:PROT

This command sets an overcurrent protection level. This is a hardware protection function similar to overvoltage protection. Although always active, its primary use is in Simulator and Table modes, which do not have the constant-current OCP protection that is available in Fixed mode. When activated, both front panel OV and OC annunciators are lit. Note that the OUT:PROT:DEL command does not apply to this hardware overcurrent protection function.

Command Syntax	[SOURce:]CURR:PROTection[:LEVe] <level>
Parameters	0 to MAX
*RST Value	Imax * 1.1
Examples	CURR:PROT 5
Query Syntax	[SOURce]:CURR:PROTection[:LEVe]?
Returned Parameters	<NRI>
Related Commands	OUTP:PROT:CLE *RST

[SOUR:]CURR:PROT:STAT

This command is active in Fixed mode only. It enables or disables the Agilent SAS overcurrent protection (OCP) function. If the overcurrent protection function is enabled and the Agilent SAS goes into constant-current operating mode, then the output is disabled and the Questionable Condition status register OC bit is set (see chapter 8 for more information). An overcurrent condition can be cleared with the OUTP:PROT:CLE command after the cause of the condition is removed.

Command Syntax	[SOURce]:CURR:PROTection:STATe <bool>
Parameters	0 1 OFF ON
*RST Value	OFF
Examples	CURR:PROT:STAT 0 CURRENT:PROTECTION:STATE OFF CURR:PROT:STAT 1 CURRENT:PROTECTION:STATE ON
Query Syntax	[SOURce]:CURR:PROTection:STATe?
Returned Parameters	<NRI> 0 or 1
Related Commands	OUTP:PROT:CLE OUTP:PROT:DEL *RST

[SOUR:]CURR:SAS:ISC

This command sets the short-circuit current for the Simulator mode. If you are programming a slave unit that is paralleled to a master unit, you must set *Isc* and *Imp* to zero (0). This configures the unit to act as a slave.

Command Syntax	[SOURce]:CURRENT:SASimulator:ISC <NRf>
Parameter for ISC	0 to 8A for Agilent E4350B (0 configures the unit as a slave) 0 to 4A for Agilent E4351B (0 configures the unit as a slave)
*RST Value	Imax
Examples	CURR:SAS:ISC 5 CURR:SAS:ISC 5;IMP 4;VOLT:SAS:VOC 60;VMP 50 CURR:SAS:ISC 0;IMP 0;VOLT:SAS:VOC 60;VMP 50 (auto paralleled slave)
Query Syntax	CURR:SAS:ISC?
Returned Parameters	<NRI>

[SOUR:]CURR:SAS:IMP

This command sets the current at the peak power point of the Simulator mode. If you are programming a slave unit that is paralleled to a master unit, you must set *Imp* and *Isc* to zero (0). This configures the unit to act as a slave.

Command Syntax	[SOURce]:CURRENT:SASimulator:IMP <NRf>
Parameter for IMP	≤ ISC (0 configures the unit as a slave)
*RST Value	0.8 X 8.16A for Agilent E4350B 0.8 X 4.08A for Agilent E4351B
Examples	CURR:SAS:IMP 4 CURR:SAS:ISC 5;IMP 4;VOLT:SAS:VOC 60;VMP 50 CURR:SAS:ISC 0;IMP 0;VOLT:SAS:VOC 60;VMP 50 (auto paralleled slave)
Query Syntax	CURR:SAS:IMP?
Returned Parameters	<NRI>

[SOUR:]CURR:TABL:NAME

This command activates a user-defined table when the unit is operating in Table mode. If the unit is not in Table mode, the specified table becomes the active table when Table mode is invoked. If you send this command with a space as the table name, it de-selects the active table. This allows the MEMory:DELeTE:ALL command to delete all tables in memory.

Command Syntax	[SOURce]:CURRENT:TABLE:NAME <name>
Parameter	a valid table name or a space
Examples	CURR:TABL:NAME curve1
Query Syntax	CURR:TABL:NAME?
Returned Parameters	<CRD>

[SOUR:]CURR:TABL:OFFS

This command adds a current offset when operating in Table mode.

Command Syntax	[SOURce]:CURRENT:TABLE:OFFSet <NRf>
Parameter	0 to Imax
*RST Value	0
Examples	CURR:TABL:OFFSet 4
Query Syntax	CURR:TABL:OFFS?
Returned Parameters	<NRI>

[SOUR:]DIG:DATA

This command sets and reads the Agilent SAS digital control port when that port is configured for Digital I/O operation. Configuring of the port is done via an internal jumper (see Appendix D). The port has three signal pins and a digital ground pin. Pins 1 and 2 are output pins controlled by bits 0 and 1. Pin 3 is controlled by bit 3 and can be programmed to serve either as an input or an output. Pin 4 is the digital ground.

Bit position 2 normally serves as an output. To change it to an input, it must first be programmed high. The **DIG:DATA?** query returns the last programmed value in bits 0 and 1 and the value read at pin 3 in bit 2. The bits are turned on and off in straight binary code as follows:

Digital I/O Port Programming Chart

Value	Bit Configuration			Pin Configuration ¹				Value	Bit Configuration			Pin Configuration ¹			
	0	1	2	1	2	3	4		0	1	2	1	2	3	4
0	0	0	0	Lo	Lo	Output	Gnd	4	0	0	1	Lo	Lo	Input	Gnd
1	1	0	0	Hi	Lo	Output	Gnd	5	1	0	1	Hi	Lo	Input	Gnd
2	0	1	0	Lo	Hi	Output	Gnd	6	0	1	1	Lo	Hi	Input	Gnd
3	1	1	0	Hi	Hi	Output	Gnd	7	1	1	1	Hi	Hi	Input	Gn

¹Pins 1 and 2 are always outputs

Command Syntax	[SOURce]:DIGital:DATA[:VALue] <NRf>
Parameters	0 to 7
*RST Value	0
Examples	DIG:DATA 7 DIGITAL:DATA:VALUE 7
Query Syntax	[SOURce]:DIGital:DATA?
Returned Parameters	<NRI> Values from 0 to 7
Related Commands	*RST *RCL *SAV

[SOUR:]VOLT
[SOUR:]VOLT:TRIG

These commands set the immediate voltage level or the pending triggered voltage level of the Agilent SAS. The immediate level is the voltage programmed for the output terminals. The pending triggered level is a stored voltage value that is transferred to the output terminals when a trigger occurs. A pending triggered level is unaffected by subsequent **VOLT** commands and remains in effect until the trigger subsystem receives a trigger or an **ABORT** command is given. If there is no pending **VOLT:TRIG** level, then the query form returns the **VOLT** level. In order for **VOLT:TRIG** to be executed, the trigger subsystem must be initiated (see **INITiate**).

Command Syntax	[SOURce]:VOLTage[:LEVel][:IMMediate][:AMPLitude] <NRf+> [SOURce][:VOLTage[:LEVel]:TRIGgered[:AMPLitude] <NRf+>
Parameters	Table 7-3
Default Suffix	V
*RST Value	Table 7-3
Examples	VOLT 200 MA VOLTAGE:LEVEL 200 MA VOLTAGE:LEVEL:IMMEDIATE:AMPLITUDE 2.5 VOLT:TRIG 20 VOLTAGE:LEVEL:TRIGGERED 20
Query Syntax	[SOURce]:VOLTage[:LEVel][:IMMediate][:AMPLitude]? [SOURce]:VOLTage[:LEVel][:IMMediate][:AMPLitude]? MAX [SOURce]:VOLTage[:LEVel][:IMMediate][:AMPLitude]? MIN [SOURce]:VOLTage[:LEVel]:TRIGgered[:AMPLitude]? [SOURce]:VOLTage[:LEVel]:TRIGgered[:AMPLitude]? MAX [SOURce]:VOLTage[:LEVel]:TRIGgered[:AMPLitude]? MIN
Returned Parameters	<NR3> VOLT? and VOLT:TRIG? return presently programmed immediate and triggered levels. If not triggered level is programmed, both returned values are the same. VOLT? MAX and VOLT? MIN return the maximum and minimum programmable immediate voltage levels. VOLT:TRIG? MAX and VOLT:TRIG? MIN return the maximum and minimum programmable triggered voltage levels.
Related Commands	For VOLT *SAV *RCL *RST For VOLT:TRIG ABOR VOLT *RST

[SOUR:]VOLT:PROT

This command sets the overvoltage protection (OVP) level of the Agilent SAS. If the output voltage exceeds the OVP level, then the Agilent SAS output is disabled and the Questionable Condition status register OV bit is set (see chapter 8 for more information). An overvoltage condition can be cleared with the **OUTP:PROT:CLE** command after the condition that caused the OVP trip is removed. The OVP always trips with zero delay and is unaffected by the **OUTP:PROT:DEL** command.

Command Syntax	[SOURce]:VOLTage:PROTection[:LEVel] <NRf+>
Parameters	Table 7-3
Default Suffix	V
*RST Value	MAX
Examples	VOLT:PROT 21.5 VOLT:PROT:LEV MAX VOLTAGE:PROTECTION:LEVEL 145E-1
Query Syntax	[SOURce]:VOLTage:PROTection[:LEVel]? [SOURce]:VOLTage:PROTection [:LEVel]? MIN [SOURce]:VOLTage:PROTection [:LEVel]? MAX
Returned Parameters	<NR3> VOLT:PROT? returns presently programmed OVP level. VOLT:PROT? MAX and VOLT:PROT? MIN return the maximum and minimum programmable OVP levels.
Related Commands	OUTP:PROT:CLE *RST *SAV *RCL

[SOUR:]VOLT:SAS:VOC

This command sets the open circuit voltage in Simulator mode. If you are programming a slave unit that is paralleled to a master unit, you must set the same Voc value to the master and the slave unit.

Command Syntax	[SOURce]:VOLTage:SASimulator:VOC <NRf>
Parameters	0 to 65V for Agilent E4350B 0 to 130V for Agilent E4351B
*RST Value	Vmax
Examples	VOLT:SAS:VOC 60
Query Syntax	[SOURce]:VOLTage:SASimulator:VOC?
Returned Parameters	<NRI>
Related Commands	VOLT:SAS:VMP

[SOUR:]VOLT:SAS:VMP

This command sets the voltage at the peak power point in Simulator mode. If you are programming a slave unit that is paralleled to a master unit, you must set the same Vmp value to the master and the slave unit.

Command Syntax	[SOURce]:VOLTage:SASimulator:VMP <NRf>
Parameters	≤ VOC
*RST Value	0.8 X 61.5V for Agilent E4350B 0.8 X 123V for Agilent E4351B
Examples	VOLT:SAS:VMP 50
Query Syntax	[SOURce]:VOLTage:SASimulator:VMP?
Returned Parameters	<NRI>
Related Commands	VOLT:SAS:VOC

[SOUR:]VOLT:TABL:OFFS

This command adds a voltage offset when operating in table mode.

Command Syntax	[SOURCE]:VOLTage:TABLE:OFFSet <NRf>
Parameter	0 to VMAX
*RST Value	0
Examples	VOLT:TABL:OFFSet 4
Query Syntax	VOLT:TABL:OFFS?
Returned Parameters	<NRI>

Status Subsystem

This subsystem programs the Agilent SAS status registers. The Agilent SAS has three groups of status registers; **Operation**, **Questionable**, and **Standard Event**. The Standard Event group is programmed with Common commands as described in "Chapter 4 - Status Reporting". The Operation and Questionable status groups each consist of the Condition, Enable, and Event registers and the NTR and PTR filters. See chapter 4 for more information about these registers.

Status Operation Registers

Bit Configuration of Operation Registers

Bit Position	15-12	11	10	9	8	7	6	5	4	3	2	1	0
Bit Name	NU	NU	CC	NU	CV	NU	NU	WTG	NU	NU	NU	NU	CAL
Bit Weight		2048	1024	512	256	128	64	32	16	8	4	2	1

CAL = Interface is computing new calibration constants; CC = The power module is in constant current mode.
CV = The power module is in constant voltage mode; NU = (Not used); WTG = Interface is waiting for a trigger.

STAT:OPER?

This query returns the value of the Operation Event register. The Event register is a read-only register which holds (latches) all events that are passed by the Operation NTR and/or PTR filter. Reading the Operation Event register clears it.

Query Syntax	STATus:OPERtion[:EVENT]?
Parameters	(None)
Returned Parameters	<NR1> (Register Value)
Examples	STAT:OPER? STATUS:OPERATIOBAL:EVENT?
Related Commands	*CLS STAT:OPER:NTR STAT:OPER:PTR

STAT:OPER:COND?

This query returns the value of the Operation Condition register. That is a read-only register which holds the real-time (unlatched) operational status of the Agilent SAS.

Query Syntax	STATus:OPERation:CONDition?
Parameters	(None)
Examples	STAT:OPER:COND? STATUS:OPERATION:CONDITION?
Returned Parameters	<NR1> (Register value)
Related Commands	(None)

STAT:OPER:ENAB

This command and its query set and read the value of the Operational Enable register. This register is a mask for enabling specific bits from the Operation Event register to set the operation summary bit (OPER) of the Status Byte register. This bit (bit 7) is the logical OR of all the Operational Event register bits that are enabled by the Status Operation Enable register.

Command Syntax	STATus:OPERation:ENABle <NRf>
Parameters	0 to 32,767
Suffix	(None)
Default Value	0
Examples	STAT:OPER:ENAB 1312 STAT:OPER:ENAB 1
Query Syntax	STATus:OPERation:ENABle?
Returned Parameters	<NR1> (Register value)
Related Commands	STAT:OPER:EVEN

STAT:OPER NTR/PTR Commands

These commands set or read the value of the Operation NTR (Negative-Transition) and PTR (Positive-Transition) registers. These registers serve as polarity filters between the Operation Enable and Operation Event registers to cause the following actions:

- When a bit in the Operation NTR register is set to 1, then a 1-to-0 transition of the corresponding bit in the Operation Condition register causes that bit in the Operation Event register to be set.
- When a bit of the Operation PTR register is set to 1, then a 0-to-1 transition of the corresponding bit in the Operation Condition register causes that bit in the Operation Event register to be set.
- If the same bits in both NTR and PTR registers are set to 1, then any transition of that bit at the Operation Condition register sets the corresponding bit in the Operation Event register.
- If the same bits in both NTR and PTR registers are set to 0, then no transition of that bit at the Operation Condition register can set the corresponding bit in the Operation Event register.

Note Setting a bit in the value of the PTR or NTR filter can of itself generate positive or negative events in the corresponding Operation Event register.

Command Syntax	STATus:OPERtion:NTRansition <NRf> STATus:OPERtion:PTRansition <NRf>
Parameters	0 to 32767
Suffix	(None)
Default Value	0
Examples	STAT:OPER:NTR 32 STAT:OPER:PTR 1312
Query Syntax	STAT:OPER:NTR? STAT:OPER:PTR?
Returned Parameters	<NR1> (Register value)
Related Commands	STAT:OPER:ENAB

STAT:PRES

This command sets all defined bits in the Status Subsystem PTR registers and clears all bits in the subsystem NTR and Enable registers. STAT:OPER:PTR is set to 1313 and STAT:QUES:PTR is set to 1555.

Command Syntax	STATus:PRESet
Parameters	(None)
Examples	STAT:PRES STATUS:PRESET
Query Syntax	(None)
Related Commands	(None)

Status Questionable Registers

Bit Configuration of Questionable Registers

Bit Position	15-11	10	9	8	7	6	5	4	3	2	1	0
Condition	NU	UNR	RI	NU	NU	NU	NU	OT	NU	NU	OC	OV
Bit Weight		1024	512	256	128	64	32	16	8	4	2	1

NU = (Not used); OC = Overcurrent protection circuit (OCP) or hardware overcurrent level (OC) has tripped.
 OT = Overtemperature status condition exists; OV = Overvoltage protection circuit has tripped.
 RI = Remote inhibit is active; UNR = Agilent SAS output is unregulated.

Note: See chapter 8 for more information about these registers.

STAT:QUES?

This query returns the value of the Questionable Event register. The Event register is a read-only register which holds (latches) all events that are passed by the Questionable NTR and/or PTR filter. Reading the Questionable Event register clears it.

Query Syntax	STATus:QUESTIONable[:EVENT]?
Parameters	(None)
Returned Parameters	<NR1> (Register Value)
Examples	STAT:QUES? STATUS:QUESTIONABLE:EVENT?
Related Commands	*CLS STAT:QUES:ENAB STAT:QUES:NTR STAT:QUES:PTR

STAT:QUES:COND?

This query returns the value of the Questionable Condition register. That is a read-only register which holds the real-time (unlatched) questionable status of the Agilent SAS.

Query Syntax	STATus:QUESTIONable:CONDition?
Parameters	(None)
Examples	STAT:QUES:COND? STATUS:QUESTIONABLE:CONDITION?
Returned Parameters	<NR1> (Register value)
Related Commands	(None)

STAT:QUES:ENAB

This command and its query set and read the value of the Questionable Enable register. This register is a mask for enabling specific bits from the Questionable Event register to set the questionable summary bit (QUES) of the Status Byte register. This bit (bit 3) is the logical OR of all the Questionable Event register bits that are enabled by the Questionable Status Enable register.

Command Syntax	STATus:QUESTIONable:ENABLE <NRf>
Parameters	0 to 32767
Suffix	(None)
Default Value	0
Examples	STAT:QUES:ENAB 20 STAT:QUES:ENAB 16
Query Syntax	STATus:QUESTIONable:ENABLE?
Returned Parameters	<NR1> (Register value)
Related Commands	STAT:QUES?

STAT:QUES NTR/PTR Commands

These commands allow you to set or read the value of the Questionable NTR (Negative-Transition) and PTR (Positive-Transition) registers. These registers serve as polarity filters between the Questionable Enable and Questionable Event registers to cause the following actions:

- When a bit in the Questionable NTR register is set to 1, then a 1-to-0 transition of the corresponding bit in the Questionable Condition register causes that bit in the Questionable Event register to be set.
- When a bit of the Questionable PTR register is set to 1, then a 0-to-1 transition of the corresponding bit in the Questionable Condition register causes that bit in the Questionable Event register to be set.
- If the same bits in both NTR and PTR registers are set to 1, then any transition of that bit at the Questionable Condition register sets the corresponding bit in the Questionable Event register.
- If the same bits in both NTR and PTR registers are set to 0, then no transition of that bit at the Questionable Condition register can set the corresponding bit in the Questionable Event register.

Note Setting a bit in the value of the PTR or NTR filter can of itself generate positive or negative events in the corresponding Questionable Event register.

Command Syntax	STATus:QUESTIONable:NTRansition <NRf> STATus:QUESTIONable:PTRansition <NRf>
Parameters	0 to 32767
Suffix	(None)
Default Value	0
Examples	STAT:QUES:NTR 16 STATUS:QUESTIONABLE:PTR 512
Query Syntax	STAT:QUES:NTR? STAT:QUES:PTR?
Returned Parameters	<NR1> (Register value)
Related Commands	STAT:QUES:ENAB

System Commands

System commands read back system errors and the SCPI version number.

SYST:ERR?

This query returns the next error number followed by its corresponding error message string from the remote programming error queue. The queue is a FIFO (first-in, first-out) buffer that stores errors as they occur. As it is read, each error is removed from the queue. When all errors have been read, the query returns **0, NO ERROR**. If more errors are accumulated than the queue can hold, the last error in the queue will be **-350, TOO MANY ERRORS** (see appendix C for error codes).

You can use the Agilent SAS front panel **Error** key to read errors from the queue. Errors generated at the front panel are not put into the queue but appear immediately on the display.

Query Syntax	SYSTem:ERRor?
Parameters	(None)
Returned Parameters	<NRI>,<SRD>
Examples	SYST:ERR? SYSTEM:ERROR?
Related Commands	(None)

SYST:VERS?

This query returns the SCPI version number to which the Agilent SAS complies. The returned value is of the form YYYY.V, where YYYY represents the year and V is the revision number for that year.

Query Syntax	SYSTEM:VERSion?
Parameters	(none)
Returned Parameters	<NR2>
Examples	SYST:VERS? SYSTEM:VERSION?
Related Commands	(None)

Trigger Subsystem

The commands in this subsystem only apply in Fixed mode. This subsystem controls the output triggering of the Agilent SAS. Trigger commands control the remote triggering of the Agilent SAS. Initiate commands initialize the trigger system.

ABOR

This command cancels any trigger actions presently in process. Pending trigger levels are reset equal to their corresponding immediate values. **ABOR** also resets the WTG bit in the Operation Condition Status register (see chapter 4). If **INIT:CONT ON** has been programmed, the trigger subsystem initiates itself immediately after **ABORt**, thereby setting WTG. **ABOR** is executed at power turn on and upon execution of ***RCL** or **RST**.

Command Syntax	ABORt
Parameters	(None)
Examples	ABOR
Related Commands	INIT *RST *TRG TRIG

INIT

This command enables the trigger system. With triggering enabled, a BUS trigger causes the output to change to its triggered level. If triggering is not enabled, all triggers are ignored.

Command Syntax	INITiate[:IMMediate]
Parameters	For INIT[:IMM] (None)
Examples	INIT INITIATE:IMMEDIATE
Related Commands	ABOR <GET> *RST TRIG *TRG

INIT:CONT

This command controls the output trigger system. The trigger system can be set as follows:

1 or **ON** continuously initiates the output trigger system. Eliminates the use of INIT for each trigger.
0 or **OFF** turns off continuous triggering. In this state, the output trigger system must be initiated prior to each trigger using the INIT command.

Command Syntax	INITiate:CONTinuous <bool>
Parameters	0 1 OFF ON
*RST Value	OFF
Examples	INIT:CONT 1 INITIATE:CONTINUOUS 1
Query Syntax	INIT:CONT?
Returned Parameters	<NR1> 0/1
Related Commands	ABOR <GET> *RST TRIG *TRG

TRIG

When the trigger subsystem is enabled, **TRIG** generates a trigger signal. The trigger will then:

1. Initiate a pending level change as specified by **CURR[:LEV]:TRIG** or **VOLT[:LEV]:TRIG**.
2. Clear the WTG bit in the Status Operation Condition register.
3. If **INIT:CONT** has been given, the trigger subsystem is immediately re-enabled for subsequent triggers. As soon as it is cleared, the WTG bit is again set to 1.

Command Syntax	TRIGger[:IMMediate]
Parameters	(None)
Examples	TRIG TRIGGER:IMMEDIATE
Related Commands	ABOR CURR:TRIG INIT *TRG VOLT:TRIG

TRIG:SOUR

This command selects the trigger source. Since the Agilent SAS has no other trigger source than the GPIB bus, this command need not be used. It is included in the command set to provide programming compatibility with other instruments (such as the Agilent Electronic Load family) that may have more than one trigger source.

Command Syntax	TRIGger:SOURce <CRD>
Parameters	BUS
*RST Value	BUS
Examples	TRIG:SOUR BUS TRIGGER:SOURCE BUS
Query Syntax	TRIGger:SOURce?
Returned Parameters	<i>BUS</i>
Related Commands	*RST *TRG TRIG[:IMM]

Status Reporting

Agilent SAS Status Structure

Figure 8-1 shows the status register structure of the Agilent SAS. The Standard Event, Status Byte, and Service Request Enable registers and the Output Queue perform standard GPIB functions as defined in the *IEEE 488.2 Standard Digital Interface* for Programmable Instrumentation. The Operation Status and Questionable Status registers implement status functions specific to the Agilent SAS. Table 8-2 and Figure 8-1 show the bit configuration of each status register.

Operation Status Group

Register Functions

The Operation Status registers record signals that occur during normal operation. The group consists of the following registers:

- A Condition register that holds real-time status of the circuits being monitored. It is a read-only register.
- A PTR/NTR (positive transition/negative transition) Filter that functions as described under **STAT:OPER:NTR|PTR COMMANDS** in chapter 7 - Language Dictionary. This is a read/write register.
- An Event register that latches any condition that is passed through the PTR or NTR filters. Reading the Event register clears it.
- An Enable register that functions as described under **STAT:OPER:ENAB** in chapter 7 - Language Dictionary. This is a read/write register.

The outputs of the Operation Status group are logically-ORed into the OPER(ation) summary bit (7) of the Status Byte register.

Register Commands

Commands that access this group are derived from the **STAT:OPER** commands described in chapter 7 - Language Dictionary and summarized in Table 8-1.

Table 8-1. Status Operation Commands

Register	Command	Query	Cleared By
Condition	(None)	STAT:OPER:COND?	Cannot be cleared
PTR Filter	STAT:OPER:PTR <NRf>	STAT:OPER:PTR?	Programming 0
NTR Filter	STAT:OPER:NTR <NRf>	STAT:OPER:NTR?	Programming 0 or STAT:PRES
Event	(None)	STAT:OPER:EVEN?	Reading or *CLS
Enable	STAT:OPER:ENAB <NRf>	STAT:OPER:ENAB?	Programming 0

Questionable Status Group

Register Functions

The Questionable Status registers record signals that indicate abnormal operation of the Agilent SAS. As shown in Figure 8-1, the group consists of the same type of registers as the Status Operation group. The outputs of the Questionable Status group are logically-ORed into the QUES(tionable) summary bit (3) of the Status Byte register.

Register Commands

Programming for this group is derived from the **STAT:QUES** commands described in chapter 7 - Language Dictionary and summarized in Table 8-3.

Table 8-3. Status :Questionable Commands

Register	Command	Query	Cleared By
Condition	(None)	STAT:QUES:COND?	Cannot be cleared
PTR Filter	STAT:QUES:PTR <NRf>	STAT:QUES:PTR?	Programming <i>0</i>
NTR Filter	STAT:QUES:NTR <NRf>	STAT:QUES:NTR?	Programming <i>0</i> or STAT:PRES
Event	(None)	STAT:QUES:EVENT?	Reading or *CLS
Enable	STAT:QUES:ENAB <NRf>	STAT:QUES:ENAB?	Programming <i>0</i>

Standard Event Status Group

Register Functions

This group consists of an Event register and an Enable register that are programmed by common commands. The Standard Event Status Event register latches events relating to interface communication status (see Figure 8-1). It is a read-only register that is cleared when read.

Read query ***ESR?**

Cleared by ***CLS *ESR?**

The Standard Event Status Enable register functions similarly to the enable registers of the Operation and Questionable status groups. The outputs of the Standard Event Status Group are logically-ORed into the RSB summary bit (5) of the Status Byte register.

Register Commands

The common ***ESE** command programs specific bits in the Standard Event Status Enable register. Because the Agilent SAS implements ***PSC**, the register is cleared at power on if ***PSC = 1**. ***ESR?** reads the Standard Event Status Event register and reading the register clears it.

Programmed by ***ESE <NRf>**

Read query ***ESE?**

Cleared by ***ESE 0**

STATUS BYTE REGISTER

This register summarizes the information from all other status groups as defined in the "IEEE 488.2 Standard Digital Interface for Programmable Instrumentation" standard. The bit configuration is shown in Figure 8-1 and Table 8-2. The register can be read either by a serial poll or by ***STB?**. Both methods return the same data, except for bit 6. Sending ***STB?** returns MSS in bit 6, while polling the register returns **RQS** in bit 6.

The RQS Bit

Whenever the Agilent SAS requests service, it sets the SRQ interrupt line true and latches RQS into bit 6 of the Status Byte register. When the controller services the interrupt, RQS is cleared inside the register and returned in bit position 6 of the response. The remaining bits of the Status Byte register are not disturbed.

The MSS Bit

This is a real-time (unlatched) summary of all Status Byte register bits that are enabled by the Service Request Enable register. MSS is set whenever the Agilent SAS has at least one reason (and possibly more) for requesting service. Sending *STB? reads the MSS in bit position 6 of the response. No bits of the Status Byte register are cleared by reading it.

Determining the Cause of a Service Interrupt

You can determine the reason for an SRQ by the following actions:

- Use a serial poll or the *STB? query to determine which summary bits are active.
- Read the corresponding Event register for each summary bit to determine which events caused the summary bit to be set. When an Event register is read, it is cleared. This also clears the corresponding summary bit.
- The interrupt will recur until the specific condition that caused each event is removed. If this is not possible, the event may be disabled by programming the corresponding bit of the status group Enable register or NTR|PTR filter. A faster way to prevent the interrupt is to disable the service request by programming the appropriate bit of the Service Request Enable register.

Service Request Enable Register

This register is a mask that determines which bits from the Status Byte register will be ORed to generate a service request (SRQ). The register is programmed with the *SRE common command. When the register is cleared, no service requests can be generated to the controller.

Output Queue

The Output Queue is a first-in, first-out (FIFO) data register that stores Agilent SAS-to-controller messages until the controller reads them. Whenever the queue holds one or more bytes, it sets the MAV bit (4) of the Status Byte register. If too many unread error messages are accumulated in the queue, a system error message is generated (see appendix D). The Output Queue is cleared at power on and by *CLS.

Initial Conditions At Power On

Status Registers

When the Agilent SAS is turned on, a sequence of commands initializes the status registers. For the factory-default *RST power-on state, Table 8-4 shows the register states and corresponding power-on commands.

Table 8-4. Default Power On Register States

Register	Condition	Caused By
Operation PTR; Questionable PTR	All bits = 1	STAT:PRE
Operation NTR; Questionable NTR	All bits = 0	STAT:PRE
Operation Event; Questionable Event	All bits = 0	*CLS
Operation Enable; Questionable Enable	All bits = 0	STAT:PRE
Standard Event Status Enable	All bits = 0 ¹	*ESE 0
Status Byte	All bits = 0	*CLS
Status Request Enable	All bits = 0 ¹	*SRE 0
Output Queue	Cleared	*CLS

¹If PSC=1. If PSC = 0, the last previous state before turn on is recalled. The value of PSC is stored in nonvolatile memory.

The PON (Power-On) Bit

The PON bit in the Standard Event register is set whenever the Agilent SAS is turned on. The most common use for PON is to generate an SRQ at power on following an unexpected loss of power. To do this, bit 7 of the Standard Event Enable register must be set so that a power-on event registers in the ESB (Standard Event Summary Bit). Also, bit 5 of the Service Request Enable register must be set to permit an SRQ to be generated. The commands to accomplish these two conditions are:

***ESE 128**

***SRE 32**

If ***PSC** is programmed to **0**, the contents of the Standard Event Enable and Service Request Enable registers are saved in nonvolatile memory and recalled at power on. This allows a PON event to generate SRQ at power on. Programming ***PSC** to **1** prevents these registers from being saved and they are cleared at power on. This prevents a PON event from generating SRQ at power on.

Examples

Note These examples are generic SCPI commands. See chapter 6 - Remote Programming for information about encoding the commands as language strings.

Servicing an Operation Status Mode Event

This example assumes you want a service request generated whenever the Agilent SAS switches to the CC (constant current) mode. From Figure 8-1, note that the required path is for a condition at bit 10 (CC) of the Operation Status register to set bit 6 (RQS) of the Status Byte register. The required register programming is shown in Table 8-5.

Table 8-5. Generating RQS from the CC Event

Register	Command	Comment
Operation PTR	STAT:OPER:PTR 1024	Allows a positive transition at the CC input (bit 10) to be latched into the Operation Status Event register. ¹
Operation Enable	STAT:OPER:ENAB 1024	Allows the latched CC event to be summed into the OPER summary bit.
Service Request Enable	*SRE 128	Enables the OPER summary bit from the Status Byte register to generate RQS.
Operation Condition	STAT:OPER:EVEN?	When you service the request, read the event register to determine that bit 10 (CC) is set and to clear the register for the next event.

¹All bits of the PTR registers bits are set to 1 at power on or in response to **STAT:PRES**.

Adding More Operation Events

To add the CV (constant voltage) event to this example, it is only necessary to add the decimal values for bit 8 (value 256) to the programming commands of the Operation Status group. The commands to do this are:

STAT:OPER:PTR 1280;ENAB 1280

It is not necessary to change any other registers, since the programming for the operation summary bit (OPER) path has already been done.

Servicing Questionable Status Events

To add OC (overcurrent) and OT (overtemperature) events to this example, program Questionable Status group bits 1 and 4.

STAT:QUES:PTR 18;ENAB 18

Next, you must program the Service Request Enable register to recognize both the questionable (QUES) and the operational (OPER) summary bits.

***SRE 136**

Now when there is a service request, read back both the operational and the questionable event registers.

```
STAT:OPER:EVENT?;QUES:EVENT?
```

Monitoring Both Phases of a Status Transition

You can monitor a status signal for both its positive and negative transitions. For example, to generate RQS when the Agilent SAS either enters the CC (constant current) condition or leaves that condition, program the Operational Status PTR/NTR filter as follows:

```
STAT:OPER:PTR 1024;NTR 1024
STAT:OPER:ENAB 1024;*SRE 128
```

The PTR filter will cause the OPER summary bit to set RQS when CC occurs. When the controller subsequently reads the event register (STAT: OPER: EVEN?), the register is cleared. When CC subsequently goes false, the NTR filter causes the OPER summary bit to again set RQS.

SCPI Command Completion

SCPI commands sent to the Agilent SAS are processed either sequentially or in parallel. Sequential commands finish execution before a subsequent command begins. Parallel commands allow other commands to begin executing while the parallel command is still executing. Commands that affect trigger actions are among the parallel commands.

The *WAI, *OPC, and *OPC? common commands provide different ways of indicating when all transmitted commands, including any parallel ones, have completed their operations. The syntax and parameters for these commands are described in chapter 7. Some practical considerations for using these commands are as follows:

- *WAI This prevents the Agilent SAS from processing subsequent commands until all pending operations are completed.
- *OPC? This places a 1 in the Output Queue when all pending operations have completed. Because it requires your program to read the returned value before executing the next program statement, *OPC? can be used to cause the controller to wait for commands to complete before proceeding with its program.
- *OPC This sets the OPC status bit when all pending operations have completed. Since your program can read this status bit on an interrupt basis, *OPC allows subsequent commands to be executed.

Note The trigger subsystem must be in the Idle state in order for the status OPC bit to be true. Therefore, as far as triggers are concerned, OPC is false whenever the trigger subsystem is in the Initiated state.

DFI (Discrete Fault Indicator)

Whenever a fault is detected in the Agilent SAS, it is capable of generating a FLT signal at the digital port (see appendix C - Digital Port Functions). The source for the DFI signal can be any Questionable, Operation, or Standard Event status event (see Figure 8-1).

RI (Remote Inhibit)

Whenever a remote inhibit signal is received at the digital port (see appendix C - Digital Port Functions), the Agilent SAS will receive an RI event at the Questionable Status register. By programming the status subsystem, you may use RI to generate a service request (SRQ) to the controller and/or to create a DFI output at the digital port. By using RI/DFI in this way, you can chain the power supplies to create a serial shutdown in response to the INH input.

To enable the OV, OC, OT, and the RI conditions to generate an FLT signal, program the Questionable Status register as follows:

```
STAT:QUES:ENAB 531
```

Using Device Clear

You can send a device clear at any time to abort a SCPI command that may be hanging up the GPIB interface. The status registers, the error queue, and all configuration states are left unchanged when a device clear message is received. Device clear performs the following actions:

- The input and output buffers of the dc source are cleared.
- The dc source is prepared to accept a new command string.

The following statement shows how to send a device clear over the GPIB interface using *Agilent BASIC*:

```
CLEAR 705           IEEE-488 Device Clear
```

The following statement shows how to send a device clear over the GPIB interface using the GPIB command library for *C* or *QuickBASIC*:

```
IOCLEAR (705)
```

Specifications and Application Information

Specifications and Supplemental Characteristics

Performance specifications are warranted over a temperature range of 0 to 40°C unless specified otherwise. Unless otherwise noted, specifications apply to Fixed, Simulator, and Table modes.

Supplemental Characteristics are not warranted but are descriptions of performance determined either by design or type testing.

Table A-1. Performance Specifications for Agilent E4350B/E4351B SAS

Parameter		Agilent E4350B	Agilent E4351B
Simulator/Table Mode Output Ratings	Maximum Power:	480 W	480 W
	Maximum Open Circuit Voltage:	65 V	130 V
	Maximum Short Circuit Current:	8 A	4 A
	Minimum Impedance ($\Delta V/\Delta I$) ¹	0.25 Ω	1 Ω
Fixed Mode Output Ratings	Voltage:	0 - 60 V	0 - 120 V
	Current:	0 - 8 A	0 - 4 A
	Current Derating Factor (from 40°C to 55°C)	0.1 A/°C	0.05 A/°C
Output Voltage Ripple & Noise (from 20 Hz to 20 MHz with a resistive load, outputs ungrounded, or either output grounded)	Simulator/Table mode:	16 mV rms 125 mV p-p	24 mV rms 195 mV p-p
	Fixed mode (constant voltage):	12 mV rms 95 mV p-p	12 mV rms 95 mV p-p
Output Current Ripple & Noise (from 20 Hz to 20 MHz with a resistive load, outputs ungrounded, or either output grounded)	Simulator/Table mode:	4 mA rms 32 mA p-p	4 mA rms 32 mA p-p
	Fixed mode (constant current):	2.4 mA rms 18 mA p-p	2.4 mA rms 18 mA p-p
Programming Accuracy ^{2,3} (@ 22°C \pm 5°C)	Fixed Mode Voltage:	0.075% +10mV	0.075% +20 mV
	Current:	0.2% +20 mA	0.2% +10 mA
Readback Accuracy ³ (from front panel or over GPIB with respect to actual output @ 22 \pm 5 °C)	Voltage:	0.08% +42mV	0.08% +84mV
	+Current:	0.20% +28mA	0.20% +14mA
	-Current:	0.35% +48mA	0.35% +24mA
Fixed Mode Load Regulation (change in output voltage or current for any load change within ratings)	Constant voltage:	2 mV	2 mV
	Constant current:	1 mA	1 mA
Fixed Mode Line Regulation (change in output voltage or current for any line voltage change within ratings)	Constant voltage:	2 mV	2 mV
	Constant current:	1 mA	1 mA

¹There is no maximum impedance restriction. Therefore, Imp can be less than or equal to Isc.

²In Simulator mode, the output current is related to the readback output voltage by an internal algorithm. In Table mode, the output current is related to the readback output voltage by interpolation between points that are entered by the user.

³The unit may go out of specification when subjected to RF fields of 3 volts/meter in the frequency range of 26 Mhz to 1 GHz.

Table A-2. Supplemental Characteristics for Agilent E4350B/E4351B SAS

Parameter		Agilent E4350B	Agilent E4351B
Output Programming Range (maximum programmable values)	<i>Simulator/Table Voltage</i>	0 - 65 V	0 - 130 V
	Fixed mode Voltage:	0 - 61.5 V	0 - 123 V
	Current:	0 - 8.16 A	0 - 4.08 A
	Overvoltage Protection:	0 - 73 V	0 - 140 V
	Overcurrent Limit:	0 - 10 A	0 - 5 A
Programming Resolution (average values)	Voltage:	18 mV	36 mV
	Current:	2.5 mA	1.25 mA
	Overvoltage Protection:	325 mV	600 mV
	Overcurrent Limit:	45 mA	23 mA
Programming Accuracy	Overvoltage Protection:	0.65 V	1.2 V
	Overcurrent Limit:	0.5% +200 mA	0.5% +100 mA
	Current Monitor:	2.5% +120mA	1.5% +60mA
	(referenced to P common)		
Fixed Mode Analog Current Programming	Analog Programming:	2.5% +5mA	1.5% +2.5mA
	+Ip to -Ip Differential Input: (0 to full scale)	0 to -4 V	0 to -4 V
	Max. common mode voltage: (referenced to +OUT)	±18 V	±18 V
	Nominal Input Impedance:	20 kΩ	20 kΩ
Output Current Settling Time (output recovery to within 1.5 A of an operating point on the I-V curve (V < 90% of VMP) after switching from a short circuit to a fixed load)		< 5 μs	< 5 μs
Drift/Temperature Stability (change in output over 8 hours under constant load, line, and ambient, following a 30-minute warmup)	Voltage:	0.04% +1 mV	0.04% +2 mV
	Current:	0.1% +0.8 mA	0.1% +0.4 mA
Temperature Coefficients (output change per °C)	Voltage:	0.01% +250 μV	0.01% +500 μV
	Current:	0.025% +200 μA	0.025% +100 μA
Output Capacitance		< 100 nF	< 50 nF
Maximum Capacitive Load (for stable operation)	<i>Simulator/Table mode:</i>	<i>No Restriction</i>	<i>No Restriction</i>
	Fixed mode:	2000 μF	2000 μF
Modulation Accuracy (for peak power tracker application)		see figure A-1	see figure A-1

Table A-2. Supplemental Characteristics for Agilent E4350B/E4351B SAS (continued)

Parameter		Both Models
AC Line Voltage Ratings (selectable via internal switching - see Appendix B)	100, 120, 220, 240 Vac: 230 Vac ¹ : Frequency Range:	-13%, +6 % -10%, +10% 47-63 Hz
Maximum Input Power		1380 VA; 1100 W (120 W with no load)
Maximum AC Line Current Ratings	in 100 Vac range: in 120 Vac range: in 220 Vac range: in 230 Vac range: in 240 Vac range:	12 A rms (15 A fuse) 10 A rms (12 A fuse) 5.7 A rms (7 A fuse) 5.3 A rms (7 A fuse) 5.3 A rms (7 A fuse)
Output Terminal Isolation (maximum, from chassis ground)		±240 Vdc
Maximum Reverse Diode Current (with fan running)		a continuous reverse diode current equal to the output current rating of the unit
Load Lead Drop with Remote Sensing	<i>Simulator/Table mode:</i> Fixed mode:	<i>up to 2 volts + (Voc - Vmp)</i> up to 2 volts total
Current Sinking Capability	<i>Simulator/Table mode:</i> Fixed mode:	350 mA 420 mA
Command Processing Time (Average time for output voltage to change after receipt of digital data when the unit is connected directly to the GPIB Bus)		20 ms
Voltage Programming Rise/Fall Time (time for output to change from 90% to 10% or 10% to 90% of its total excursion)		< 8 ms
Voltage Programming Settling Time (time for output change to settle within 0.1% of the rating of the unit; either 60mV or 120 mV)		< 25 ms
Monotonicity		Output is monotonic over entire rated voltage, current, temperature range
Auto-Parallel Configuration		Up to three identical models
Non-volatile Savable States	Memory Locations: Memory Write Cycles: Prestored state	5 (0 through 4) 40,000 typical location 0

¹Unit wiring for 230 Vac ± 10% is identical to 240 Vac -13% + 6%.

Table A-2. Supplemental Characteristics for Agilent E4350B/E4351B SAS (continued)

INH/FLT Characteristics	<p>Maximum ratings:</p> <p>FLT Terminals (1 & 2):</p> <p>INH Terminals (3 & 4):</p>	<p>16.5 Vdc between terminals 1 & 2; 3 & 4; and from 1 or 2 to chassis ground</p> <p>Low-level output current = 1.25 mA max. Low-level output voltage = 0.5 V max.</p> <p>Low-level input voltage = 0.8 V max. High-level input voltage = 2 V min. Low-level input current = 1 mA Pulse width = 100 μs min. Time delay = 4 ms typical</p>
Digital I/O Characteristics	<p>Maximum ratings:</p> <p>Digital OUT Port 0,1,2 (open collector)</p> <p>Digital IN Port 2: (internal pull-up)</p>	<p>same as INH/FLT Characteristics</p> <p>Output leakage @ 16V = 0.1 mA (ports 0,1) = 12.5 mA (port 2) Output leakage @ 5V = 0.1 mA (ports 0,1) = 0.25 mA (port 2) Low-level output sink current @ 0.5 V = 4 mA Low-level output sink current @ 1 V = 50 mA</p> <p>Low-level input current @ 0.4 V = 1.25 mA High-level input current @ 5 V = 0.25 mA Low-level input voltage = 0.8 V max. High level input voltage = 2.0 V min.</p>
GPIB Interface Capabilities	<p>Languages:</p> <p>Interface:</p>	<p>SCPI</p> <p>AH1, C0, DC1, DT1, E1, LE4, PP0, RL1, SH1,SR1, TE6</p>
Serial Link Capabilities (multiple supplies sharing one GPIB primary address)	<p>Max number of units:</p> <p>Max number of linked units:</p> <p>Max total chain length:</p>	<p>16</p> <p>15</p> <p>30 m (100 ft)</p>
Calibration Interval (recommended)		<p>1 year (from date the unit is put into service)</p>
Regulatory Compliance	<p>Listing pending:</p> <p>Certified to:</p> <p>Conforms to:</p> <p>Complies with:</p>	<p>UL 3111-1 CSA 22.2 No. 1010.1 IEC 1010-1 EMC directive 89/336 EEC (ISM Group1 Class B)</p>
Dimensions (see figure 3-1)	<p>Height:</p> <p>Width:</p> <p>Depth (with safety cover):</p>	<p>132.6 mm (5.22 in.) 425.5 mm (16.75 in.) 497.8 mm (19.6 in.)</p>
Weight	<p>Net</p> <p>Shipping</p>	<p>25 kg (54 lbs.) 28 kg (61 lbs.)</p>

Output Impedance Graphs

Simulator Mode

The following six output impedance graphs were generated at three points on both Agilent SAS models while operating in simulator mode with the reference settings indicated below. The reference curve shows the location of the three sample points on which the output impedance graphs are based.

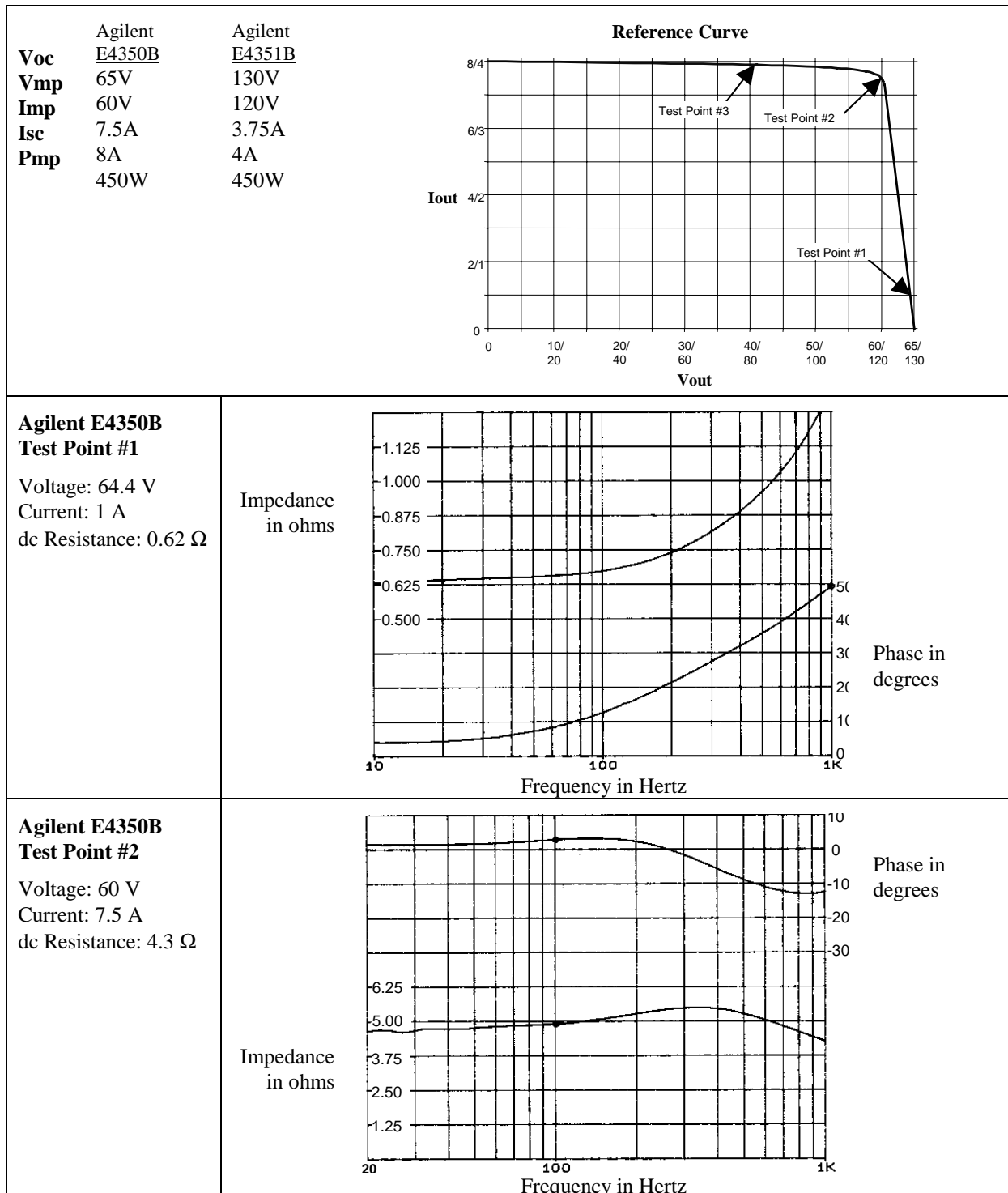

<p>Agilent E4350B Test Point #3</p> <p>Voltage: 40.75 V Current: 7.9 A dc Resistance: 200 Ω</p>	<p>Impedance in ohms</p> <p>Phase in degrees</p> <p>Frequency in Hertz</p>
<p>Agilent E4351B Test Point #1</p> <p>Voltage: 128.8 V Current: 0.5 A dc Resistance: 2.48 Ω</p>	<p>Impedance in ohms</p> <p>Phase in degrees</p> <p>Frequency in Hertz</p>
<p>Agilent E4351B Test Point #2</p> <p>Voltage: 120 V Current: 3.75 A dc Resistance: 17.2 Ω</p>	<p>Impedance in ohms</p> <p>Phase in degrees</p> <p>Frequency in Hertz</p>

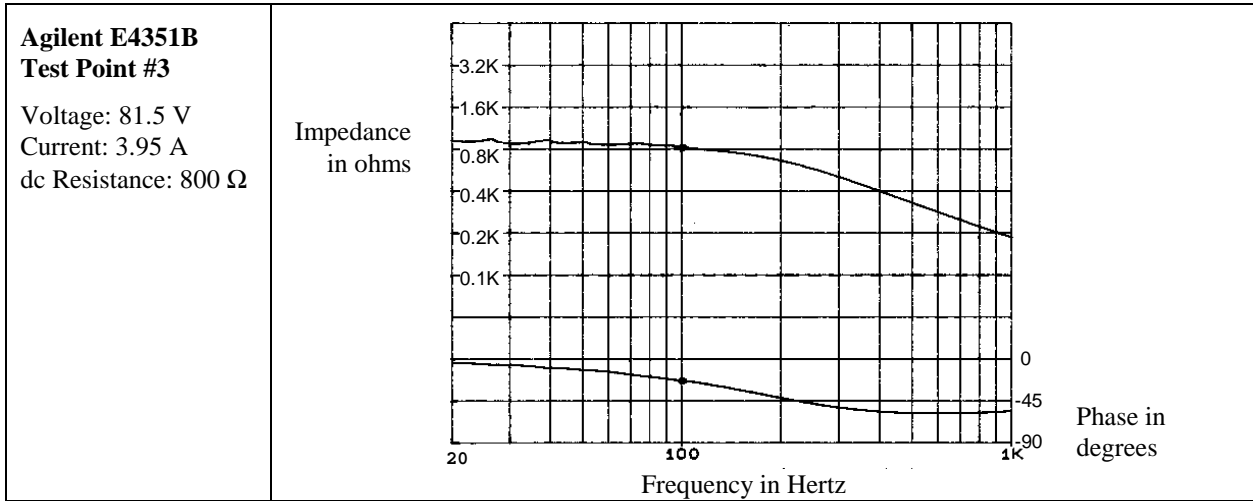

Fixed Mode

The following four output impedance graphs were generated while both Agilent SAS models were operating in Fixed mode during constant voltage and constant current operation.

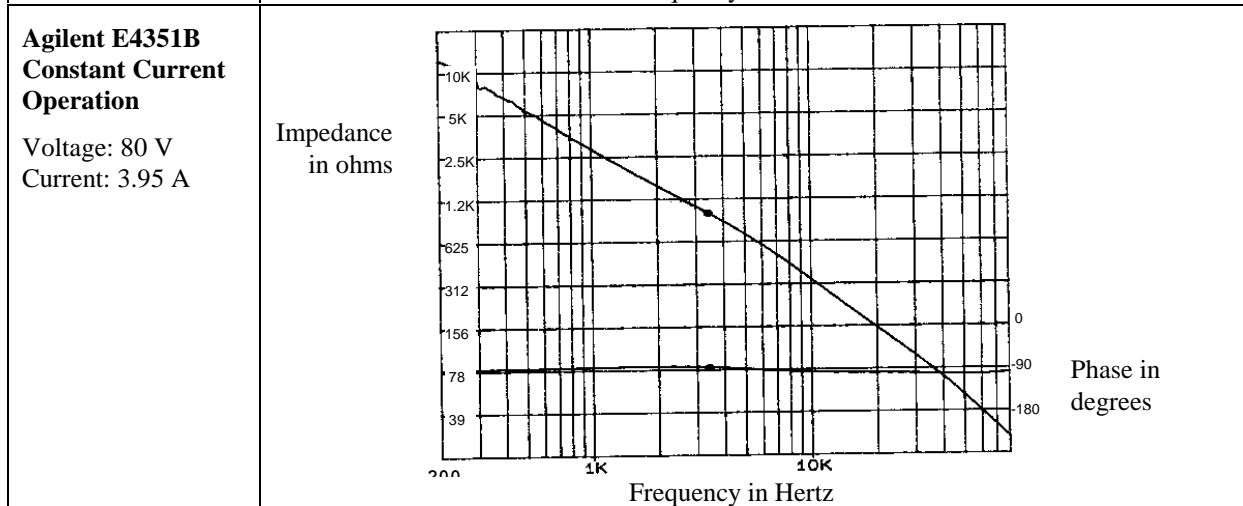
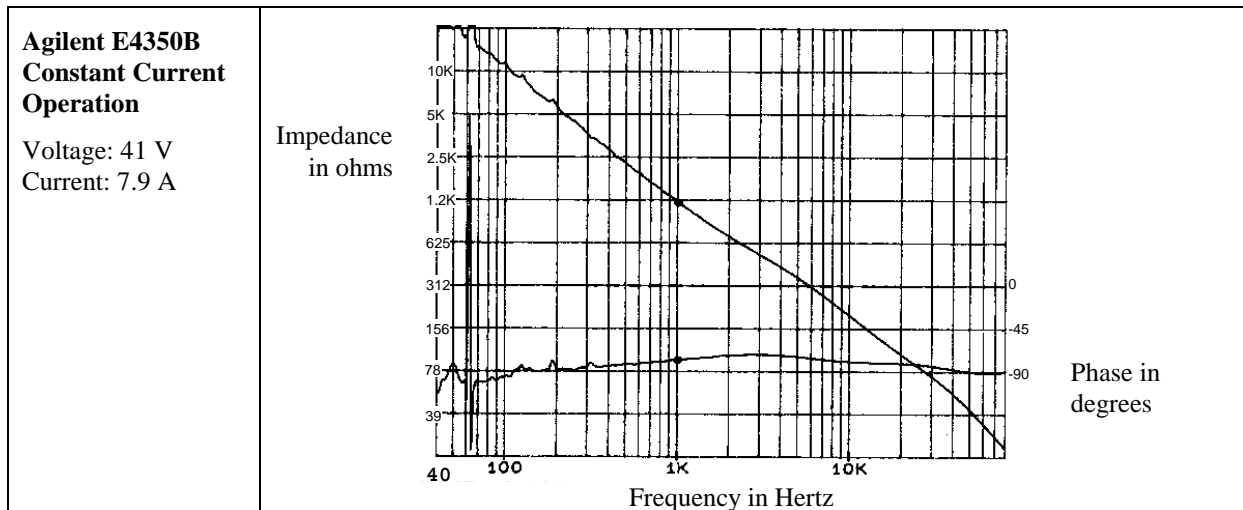

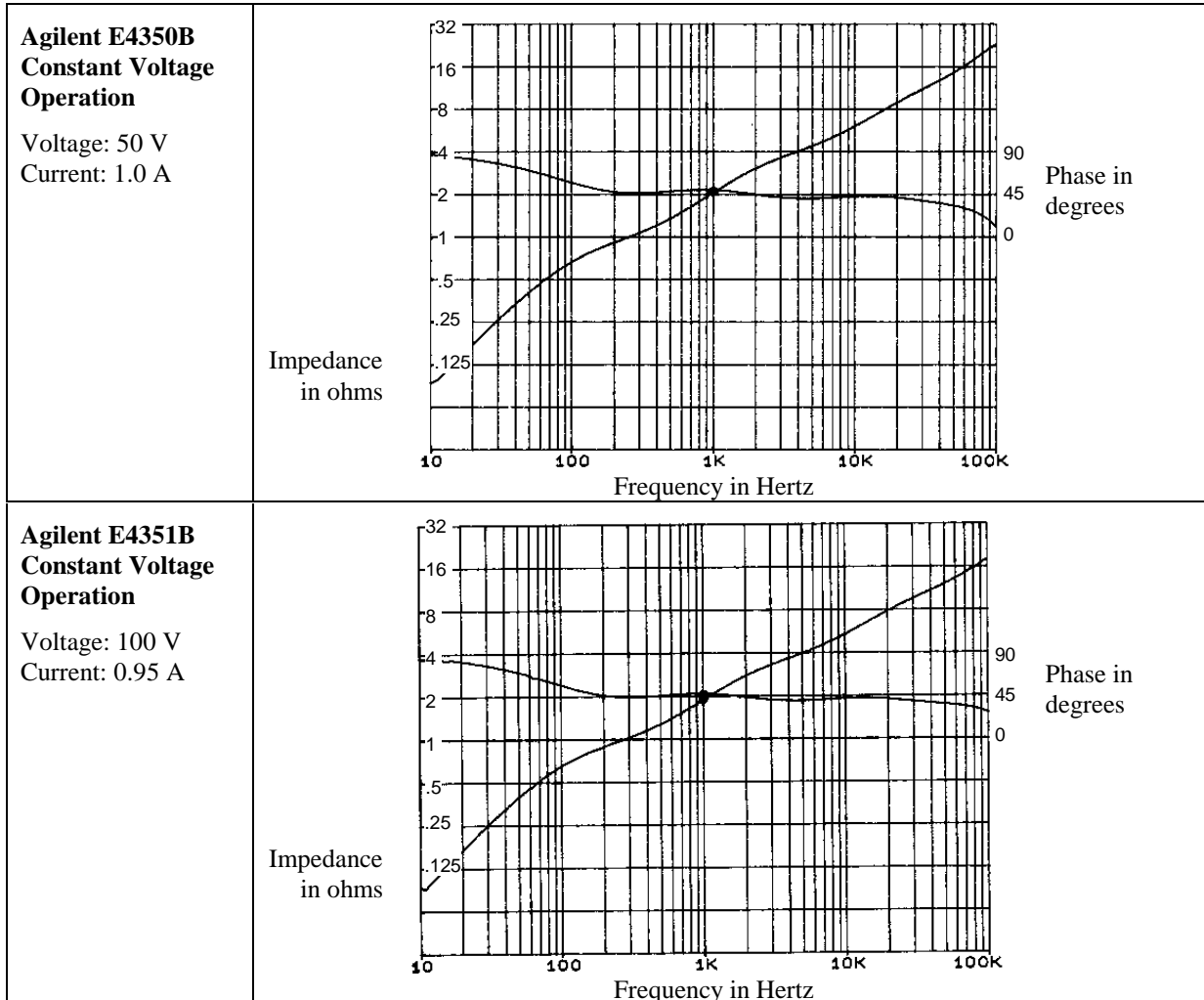

Peak Power Tracker Application

The peak power tracker is a customer-provided application. In this application, the load is constantly searching for the maximum power point of the I-V curve. To achieve this the peak power tracker sweeps around the peak power point. The Agilent SAS can be used in this application in either Simulator mode or in Table mode. Note that the ability of the Agilent SAS to track the I-V curve depends on both the excursion from the peak power point and the modulation frequency.

The following graph depicts the Agilent SAS peak power tracking error for both models. The load is sinusoidally swept from -5%, -10%, or -15% on one side of Pmp to -5%, -10% or -15% on the other side of Pmp. As the frequency of the sweep is increased, the tracking error will increase as indicated by the graph.

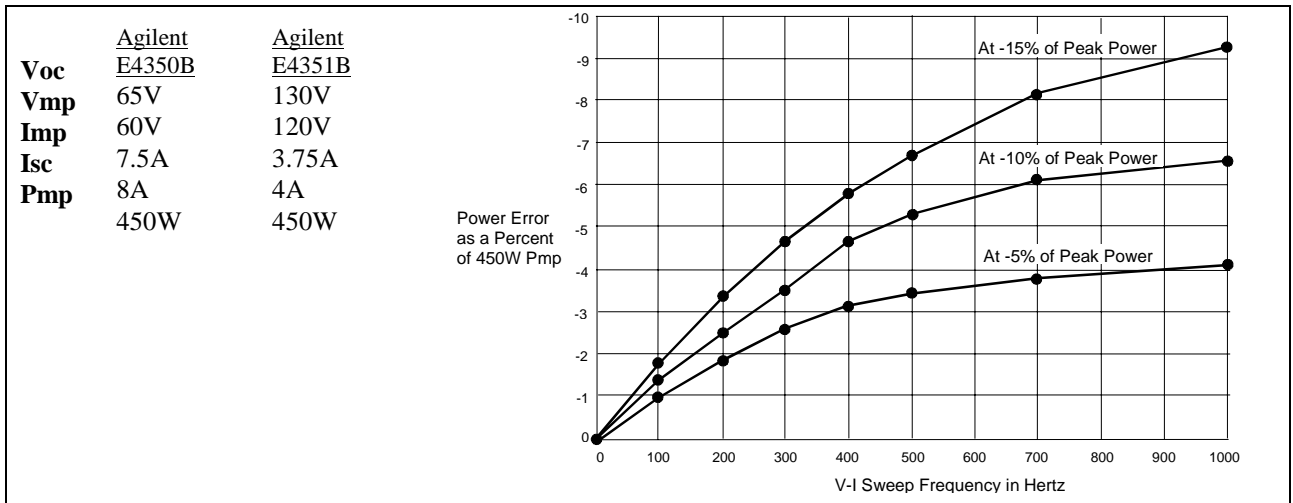

Figure A- 1. Percent Power Error in Simulator Mode

Exponential Model Equations*

The following equations describe the solar array simulator exponential model using the parameters Rs, N, and a, which are defined as functions of the four input parameters.

$$R_s = \frac{V_{oc} - V_{mp}}{I_{mp}} \quad N = \frac{\ln(2 - 2^a)}{\ln\left(\frac{I_{mp}}{I_{sc}}\right)} \quad a = \frac{V_{mp}\left(1 + \frac{R_s I_{sc}}{V_{oc}}\right) + R_s(I_{mp} - I_{sc})}{V_{oc}} \quad V = \frac{V_{oc} \ln\left(2 - \left(\frac{I}{I_{sc}}\right)^N\right)}{\ln(2) - \frac{R_s(I - I_{sc})}{1 + \frac{R_s I_{sc}}{V_{oc}}}}$$

Note that these equations tend to be most accurate for curves that are somewhat rectangular.** Figure A-2 indicates the potential range of Pmp error percent due to the modeling equation. The x-axis parameter is (Voc/Vmp) * (Isc/Imp), which is a measure of the rectangularity of the simulator curve, with values near 1 being highly rectangular. The y-axis is a measure of the possible error of the curve algorithm equation at the peak power point as defined by the following equation:

$$\% Pmp_{error} = \left(\frac{Equation_{pmp}}{(I_{mp})(V_{mp})} - 1 \right) * 100\%$$

For example, a curve with the reference settings described in figure A-1 gives an x-axis value of 1.16, with an equation accuracy for Pmp that is better than 1%.

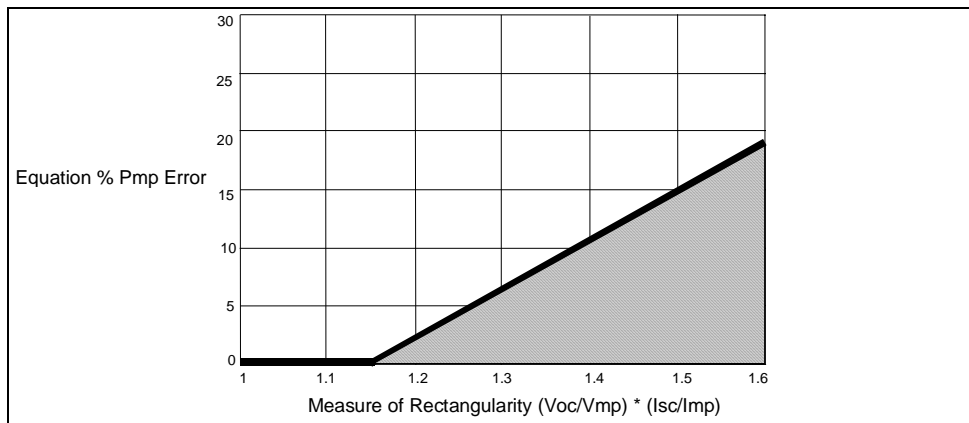

Figure A-2. Range of Pmp Error Due to Modeling Equation

*The exponential model is described in the paper: Britton, Lunscher, and Tanju, "A 9 KW High-Performance Solar Array Simulator", Proceedings of the European Space Power Conference, August 1993 (ESA WPP-054, August 1993).

**The potential error between the equation's actual peak power and the expected peak power (Vmp * Imp) will increase as the curves become less rectangular.

Series Switching Regulation

In this application, regulation across the load can be achieved by controlling the duty cycle of a series FET, which can be operated at frequencies as high as 50kHz. A proprietary non-dissipative clamp circuit minimizes output voltage overshoots when the output of the Agilent SAS is quickly unloaded.

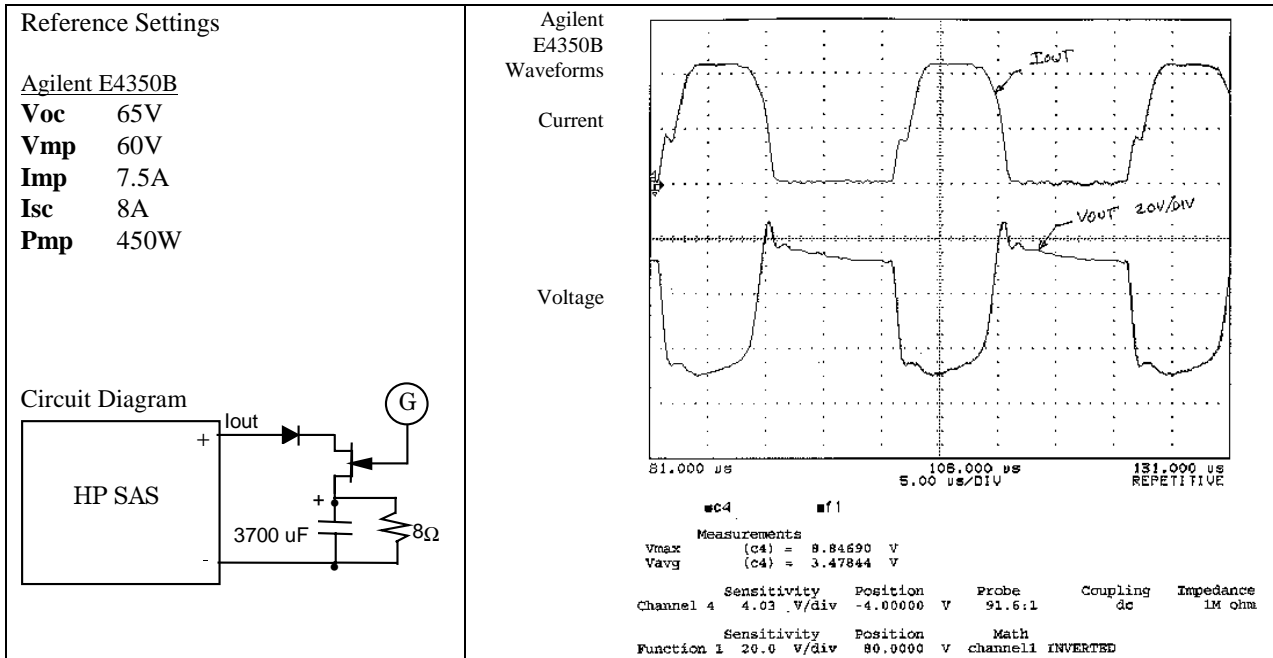

Shunt Switching Regulation

In this application, regulation across the load is achieved by controlling the duty cycle of a shunt FET, which can be operated at frequencies as high as 50kHz. Note the relatively clean output current waveform, which can be attributed to the fast dynamic response and low output capacitance of the Agilent SAS.

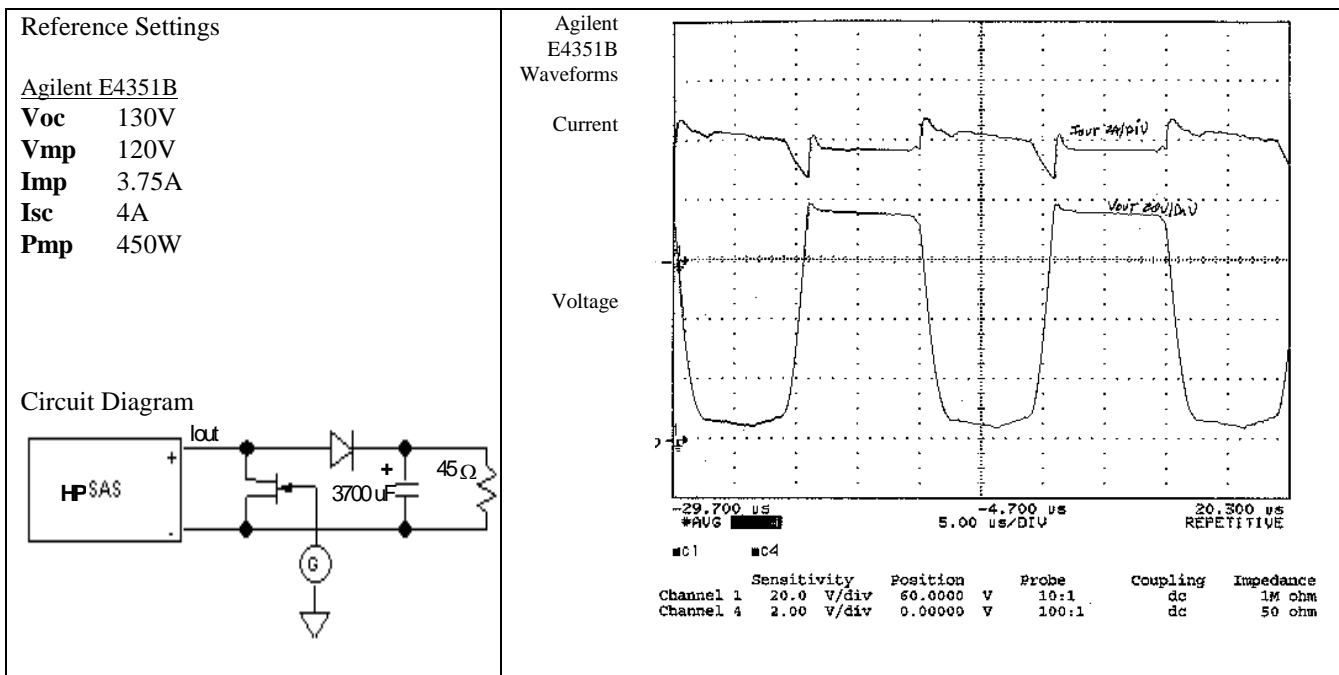

Verification and Calibration

Introduction

This appendix includes verification and calibration procedures for the Agilent E4350B and E4351B SAS. Instructions are given for performing the procedures either from the front panel or from a controller over the GPIB.

The verification procedures do not check all the operating parameters, but verify that the Agilent SAS is performing properly. Performance Tests, which check all the specifications of the dc source, are given in the applicable Service Manual. The required test equipment and acceptable test results are specified in tables in this appendix.

Note Performance Tests, which check all the specifications of the Agilent SAS, are given in the Service Manual.

Test Equipment Required

The following equipment is required to perform the tests:

Table B-1. Equipment Required for Verification and Calibration

Equipment	Characteristics	Recommended Model
Digital Voltmeter	Resolution: 10 nV @ 1 V Readout: 8 1/2 digits DC Accuracy: 0.005%, 6 digits, 20 ppm	Agilent 3458A
Current Monitor Resistor	15 A, 0.1 Ω , 0.04%, 25 W	Guidline 9230/15
For Calibration Over the GPIB	HP Vectra (or IBM compatible) with GPIB Interface, or Agilent BASIC series	

Current Monitoring Resistor

The 4-terminal current-monitoring resistor listed in Table B-1 is required to eliminate output current measurement error caused by voltage drops in leads and connections. The specified resistors have special current-monitoring terminals inside the load connection terminals. Connect the DVM directly to these current-monitoring terminals.

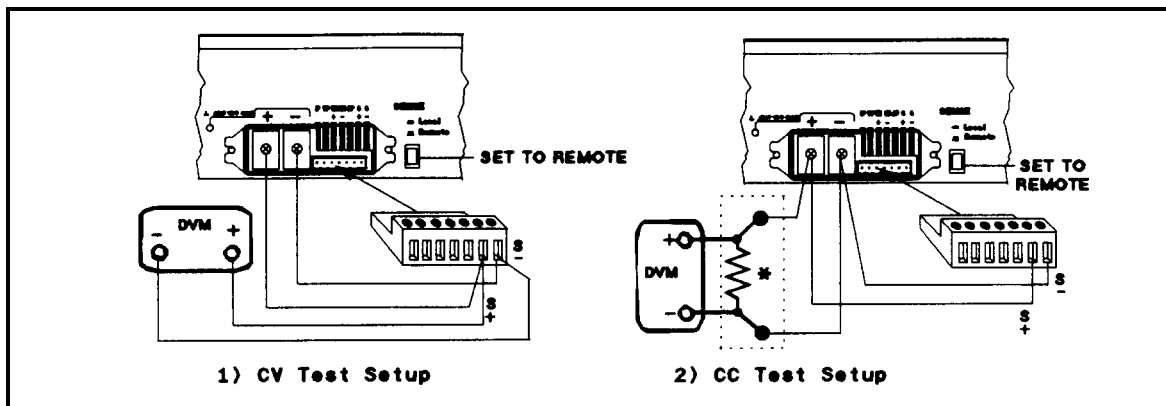

Figure B-1. Verification and Calibration Test Setup

Verification

General Measurement Techniques

Figure B-1 shows the setup for the tests. Be certain to use load leads of sufficient wire gauge to carry the output current (see Table 4-1). To avoid noise pickup, use coaxial cable or shielded pairs for the test leads.

Programming the Agilent SAS

Table 7-3 in chapter 7 list the programming voltage and current ranges for each model. Enter the appropriate values from the front panel. The programming procedures assume you know how to operate the Agilent SAS from the front panel (see chapter 5 - Front Panel Operation).

Order of Tests

Perform the following tests for operation verification. Test 1 must be done first, followed by Tests 2 and 3 in any order.

- 1 Turn-on Checkout
- 2 Voltage Programming and Readback Accuracy
- 3 Current Programming and Readback Accuracy

Turn-on Checkout

Perform the Turn-on Checkout as directed in chapter 3 - Turn-on Checkout.

Note The Agilent SAS must pass turn-on selftest before you can proceed with these tests.

Voltage Programming and Readback Accuracy

This test verifies that the voltage programming, GPIB readback, and front panel display functions are within specifications. Figure B-1 shows the setup for the tests. Measure the dc output voltage directly at the sense connections of the output terminals or bus bars. Connect the output as shown.

Table B-2. Voltage Programming and Readback Accuracy Tests

	Action	Normal Result
1	Turn off the Agilent SAS and connect a DVM across the sense terminals (see Figure B-1(1)).	
2	Turn on the Agilent SAS with no load and program the output for 0 volts and maximum programmable current.	CV annunciator on. Output current near 0.
3	Record voltage readings of voltmeter (V_{DVM}) and front panel display readback (V_{FP}) in Table B-4.	Readings within Low Voltage limits (see Table B-4 for either Agilent E4350B or Agilent E4351B).
4	Program voltage to full scale (either 60 V or 120 V).	
5	Record voltage readings of voltmeter (V_{DVM}) and front panel display readback (V_{FP}) in Table B-4.	Readings within High voltage limits (see Table B-4 for either Agilent E4350B or Agilent E4351B).

Current Programming and Readback Accuracy

This test verifies that the current programming and readback are within specification. Connect the appropriate current monitoring resistor (see Table B-1) as shown in Figure B-1(2). The accuracy of the resistor must be as specified in the table.

Table B-3. Current Programming and Readback Accuracy Test

	Action	Normal Result
1	Turn off the Agilent SAS and connect the current monitoring resistor as shown in Figure B-1(2). Be certain to use wire of sufficient size to carry the maximum rated current of the supply (see Table 4-1 in Chapter 4).	
2	Connect a DVM across the resistor.	
3	Turn on the Agilent SAS and program the output for 5 volts and 0 amperes.	
4	Disable the output (<input type="button" value="Output Off"/>)	
5	Enable the output <input type="button" value="Output On"/> (or send OUTPut ON).	
6	Observe the voltage reading of the voltmeter. Divide this by the resistance of the current monitor resistor. Record the result as the Low Current value (I_{DVM}) in Table B-4.	Value within Low Current limits (see Table B-4 for either Agilent E4350B or Agilent E4351B).
7	Record the front panel display readback (I_{FP}) in Table B-4.	Value within specified readback limits (see Table B-4 for either Agilent E4350B or Agilent E4351B).
8	Program output current to full scale (either 8 A or 4A).	
9	Repeat Steps 6 and 7.	Both current readings within specified High Current and readback limits (see Table B-4 for either Agilent E4350B or Agilent E4351B).
10	Disable the output (<input type="button" value="Output Off"/>).	
11	Remove the short from across the load.	

Table B-4. Operation Verification Test Parameters

Test Description	Minimum Spec	Results *	Maximum Spec	Measurement Uncertainty
MODEL Agilent E4350B				
Voltage Programming and Readback				
Low Voltage (0 V)	-10 mV	$V_{DVM} = \text{_____ mV}$	+10 mV	2.0 μ V
Front Panel Display Readback	$V_{DVM} -42 \text{ mV}$	$V_{FP} = \text{_____ mV}$	$V_{DVM} +42 \text{ mV}$	2.0 μ V
High Voltage (60 V)	59.945 V	$V_{DVM} = \text{_____ V}$	60.055 V	845 μ V
Front Panel Display Readback	$V_{DVM} -90 \text{ mV}$	$V_{FP} = \text{_____ mV}$	$V_{DVM} +90 \text{ mV}$	845 μ V
Current Programming and Readback				
Low Current (0 A)	-20 mA	$I_{DVM} = \text{_____ mA}$	+20 mA	16 μ A
Front Panel Display Readback	$I_{DVM} -28 \text{ mA}$	$I_{FP} = \text{_____ mA}$	$I_{DVM} +28 \text{ mA}$	16 μ A
High Current (8 A)	7.964 A	$I_{DVM} = \text{_____ A}$	8.036 A	2.5 mA
Front Panel Display Readback	$I_{DVM} -44 \text{ mA}$	$I_{FP} = \text{_____ mA}$	$I_{DVM} +44 \text{ mA}$	2.5 mA

Table B-4. Operation Verification Test Parameters (continued)

Test Description	Minimum Spec	Results *	Maximum Spec	Measurement Uncertainty
MODEL Agilent E4351B				
Voltage Programming and Readback				
Low Voltage (0 V)	-20 mV	V _{DVM} = _____ mV	+20 mV	2.0 μV
Front Panel Display Readback	V _{DVM} -84 mV	V _{FP} = _____ mV	V _{DVM} +84 mV	2.0 μV
High Voltage (60 V)	119.89 V	V _{DVM} = _____ V	120.11 V	1.7 mV
Front Panel Display Readback	V _{DVM} -180 mV	V _{FP} = _____ mV	V _{DVM} +180 mV	1.7 mV
Current Programming and Readback				
Low Current (0 A)	-10 mA	I _{DVM} = _____ mA	+10 mA	15 μA
Front Panel Display Readback	I _{DVM} -14 mA	I _{FP} = _____ mA	I _{DVM} +14 mA	15 μA
High Current (8 A)	3.982 A	I _{DVM} = _____ A	4.018 A	586 μA
Front Panel Display Readback	I _{DVM} -22 mA	I _{FP} = _____ mA	I _{DVM} +22 mA	586 μA
* Enter your test results in this column.				

Calibration

Important The Agilent SAS can only be calibrated in Fixed mode. Mode switching is accomplished over the GPIB bus via the SCPI CURRent:MODE command.

The Agilent SAS may be calibrated either from the front panel or from a controller over the GPIB. The procedures given here apply to both models. The recommended calibration interval is once a year. Note that these instructions do not include verification procedures. If you need to perform verification as a prerequisite to or as part of your calibration procedure, see "Verification".

Test Equipment Required

The equipment listed in Table B-1, or equivalent, is required for calibration.

General Procedure

WARNING

Because the Agilent SAS output must be enabled during calibration, voltages or currents hazardous to personnel and/or damaging to equipment can appear at the output terminals.

Parameters Calibrated

The following parameters may be calibrated:

- Output voltage.
- Output voltage readback.
- Overvoltage protection (OVP).
- Output current.
- Output current readback.

You do not have to do a complete calibration each time. If appropriate, you may calibrate only the voltage or current and proceed to "Saving the Calibration Constants".

Figure B-1 shows the test setups required for voltage and current calibration.

Front Panel Calibration

Eight shifted keys and the Entry keypad are used for calibration functions (see chapter 5 - Front Panel Operation for explanations of shifted keys and the Entry keypad). The following procedures assume you understand how to operate front panel keys.

Entering the Calibration Values

Follow the steps in Table B-5 for entering calibration values.

Saving the Calibration Constants

CAUTION Storing calibration constants overwrites the existing ones in nonvolatile memory. If you are not absolutely sure you want to permanently store the new constants, omit this step. The Agilent SAS calibration will then remain unchanged.

To replace any existing calibration constants with ones you have just entered, press **Cal Save**. **CAL SAVED** then appears on the display.

Disabling the Calibration Mode

To disable the calibration mode, press **Cal Disable**. The display will return to meter mode with the **Cal** annunciator off.

Changing the Calibration Password

The factory default password is the model number of your supply, such as 4350. You can change the calibration password only when the Agilent SAS is in the calibration mode (which requires you to enter the existing password). Proceed as follows:

1. Press **Pass**.
2. Enter the new password from the keypad. (You can use up to 6 integers and an optional decimal point.) If you want **Cal Enable** to operate without requiring any password, change the password to 0 (zero).
3. **AGAIN** will appear on the display. Enter the password a second time.
4. When **OK** is displayed, the new password has been accepted.

Table B-5. Typical Front Panel Calibration Procedure

Action	Display Response
<p style="text-align: center;">Enabling the Calibration Mode</p> <p>1. Begin calibration by pressing Cal Enable.</p> <p>2. Enter calibration password from Entry keypad. If password is correct the Cal annunciator will come on. If password is incorrect, an error occurs². Note: The initial (factory-default) password is the model number of the Agilent SAS, but it can be changed (see "Changing the Password").</p>	<p>PASWD¹</p> <p>PASSWD ERROR</p>
<p style="text-align: center;">Entering Voltage Calibration Values</p> <p>1. Make certain the DVM is the only load on the Agilent SAS.</p> <p>2. Select the first calibration point by pressing Vcal. If the Agilent SAS is not in CV mode, an error occurs³</p> <p>3. Read the DVM and use the Entry keypad to enter the first voltage value.</p>	<p>(Meter mode) VRDG1 WRONG MODE (Meter mode)</p>

Table B-5. Typical Front Panel Calibration Procedure (continued)

Action	Display Response
4. Select the second calibration point by pressing (Vcal) again. 5. Read the DVM and use the Entry keypad to enter the second voltage value. Note: If one of the entered values is not within acceptable range, an error occurs. <i>The Agilent SAS is now holding the new voltage calibration constants in RAM.</i>	VRDG2 (Meter mode) CAL ERROR
<p style="text-align: center;">Calibrating the OVP Trip Point</p> 1. Make certain the voltage has been calibrated and there is no load on the Agilent SAS. 2. Select OVP calibration by pressing (OVCal) . 3. Wait for the Agilent SAS to compute the OVP calibration constant. If the supply goes unregulated or into CC mode during OVP calibration, an error occurs. If the computed constant is out of acceptable range, an error occurs. <i>The Agilent SAS is now holding the new OVP calibration constant in RAM.</i>	(Meter mode) OVPCAL CAL COMPLETE NOT CV MODE DOES NOT CAL
<p style="text-align: center;">Entering Current Calibration Values</p> 1. Make certain appropriate shunt resistor (see Table A-1) is the only load on the Agilent SAS. 2. Select the first calibration point by pressing (Ical) . If the Agilent SAS is not in CC mode, an error occurs. ⁴ 3. Wait for DVM reading to stabilize. Then read DVM and compute the first current value (DVM reading ÷ shunt resistance). 4. Use Entry keypad to enter the first current value. 5. Select second calibration point by pressing (Ical) again. 6. Wait for DVM reading to stabilize. Then read DVM and compute the second current value (DVM reading ÷ shunt resistance). 7. Use Entry keypad to enter the second current value. Note: If the entered value is not within acceptable range, an error occurs. <i>Wait for the Agilent SAS to compute the new current calibration constants, which will be stored in RAM.</i>	(Meter mode) IRDG1 WRONG MODE (Meter mode) (Meter mode) IRDG2 (Meter mode) CAL ERROR CAL COMPLETE
<p>NOTES</p> <ol style="list-style-type: none"> ¹ If CAL DENIED appears, then an internal jumper has been set to prevent the calibration from being changed. (See the <i>Service Manual</i>.) ² If the active password is lost, the calibration function can be recovered by moving an internal jumper that defeats password protection. However, this also will change all calibration constants to their factory-default values. (For more information, see the <i>Service Manual</i>.) ³ Program the output current to 10% of its rated output* ⁴ Program the output voltage to 10% of its rated output* <p>* See applicable Output Ratings in appendix A</p>	

Recovering From Calibration Problems

You can encounter serious calibration problems if you cannot determine a calibration password that has been changed or the Agilent SAS is severely out of calibration. There are jumpers inside the Agilent SAS that permit the calibration password to be defeated and allow the original factory calibration constants to be restored. These jumpers are explained in the *Service Manual*.

Calibration Error Messages

Error messages that can occur during calibration are shown in Table B-6.

Table B-6. GPIB Calibration Error Messages

Error No.	Meaning	Error No.	Meaning
1	CAL jumper prevents calibration ¹	5	Incorrect computed programming constants
2	CAL password is incorrect	6	Wrong CAL command sequence
3	CAL mode is not enabled	7	Incorrect state (CV/CC) for this command
4	Incorrect computed readback constants		

¹ This is a hardware disable. See the Agilent SAS *Service Manual*.

Calibration Over The GPIB

You can calibrate the Agilent SAS by using SCPI commands within your controller programming statements. Be sure you are familiar with calibration from the front panel before you calibrate from a controller. The SCPI calibration commands are related to the front panel calibration controls as follows:

Front Panel Command	Corresponding SCPI Command	Front Panel Command	Corresponding SCPI Command
Cal Enable	CAL:STAT {ON 1},<password>	OVCal	CAL:VOLT:PROT
Cal Disable	CAL:STAT {OFF 0}	Ical	CAL:CURR:LEV {MIN MAX} CAL:CURR[:DATA] <NRf>
Pass	CAL:PASS <NRf>	Cal Save	CAL:SAVE
Vcal	CAL:VOLT:LEV {MIN MAX} CAL:VOLT[:DATA] <NRf>		

Calibration Example

A sample calibration program is given at the end of this appendix. If your system is Agilent BASIC, you can use the program with very little modification. Otherwise, use it as a guide for writing your own program.

Calibration Language Dictionary

The calibration commands are listed in alphabetical order. The format for each command follows that shown in chapter 7 - Language Dictionary. Calibration error messages that can occur during GPIB calibration are shown in Table B-6.

CAL:CURR

This command is used to calibrate the output current. The command enters current value that you obtain from an external meter. (If you are entering the current value, allow time for the DVM to stabilize.) You must first select a calibration level (**CAL:CURR:LEV**) for the value being entered. Two successive values (one for each end of the calibration range) must be selected and entered. The Agilent SAS then computes new current calibration constants. These constants are **not** stored in nonvolatile memory until saved with the **CAL:SAVE** command.

Command Syntax	CALibrate:CURRENT[:DATA] <NRf>
Parameters	(See applicable Output Ratings specification in appendix A)
Default Suffix	A
Examples	CAL: CURR 32 . 33 A CAL: CURR: DATA 5 . 00
Related Commands	CAL:SAVE CAL:STAT

CAL:CURR:LEV

This command sets the Agilent SAS to a calibration point that is then entered with **CAL:CURR[:DATA]**. During calibration, two points must be entered and the low-end point (MIN) must be selected and entered first.

Command Syntax	CALibrate:CURRENT:LEVel {MIN MAX}
Parameters	{<CRD> MINimum MAXimum}
Examples	CAL: CURR: LEV MIN CAL: CURR: LEV MAX
Related Commands	CAL:CURR[:DATA] CAL:STAT

CAL:PASS

This command enters a new calibration password. The command is active only when the Agilent SAS is already in the calibration mode. Unless it is changed subsequently to shipment, the password is the Agilent SAS's model number. If the password is set to 0, password protection is removed and **CAL:STAT ON** is unrestricted. A new password is automatically stored in nonvolatile memory and does not have to be stored with the **CAL:SAVE** command.

Command Syntax	CALibrate:PASScode <NRf>
Parameters	<NRf>
Examples	CAL:PASS 4350 CAL:PASS 09.1993
Related Commands	CAL:STAT

CAL:SAVE

This command saves any new calibration constants (after a current or voltage calibration procedure has been completed) in nonvolatile memory.

Command Syntax:	CALibrate:SAVE
Parameters	(None)
Examples	CAL: SAVE
Related Commands	CAL:CURR CAL:VOLT CAL:STAT

CAL:STAT

This command enables and disables the calibration mode. The calibration mode must be enabled before the Agilent SAS will accept any other calibration commands. The first parameter specifies the enabled or disabled state. The second parameter is the password. It is required if the calibration mode is being enabled and the existing password is not 0. If the second parameter is not entered or is incorrect, an error is generated and the calibration mode remains disabled. The query statement returns only the state, not the password. **Note** that whenever the calibration mode is changed from enabled to disabled, any new calibration constants are lost unless they have been stored with CAL:SAVE.

Command Syntax:	CALibrate:STATe <bool> [,<NRf>]
Parameters	{0 OFF} {1 ON} [,<NRf>]
*RST Value	OFF
Examples	CAL:STAT 1,4350 CAL:STAT OFF
Query Syntax	CALibrate:STATe?
Returned Parameters	{0 1 }
Related Commands	CAL:PASS CAL:SAVE

CAL:VOLT

This command is used to calibrate the output voltage. The command enters voltage value that you obtain from an external meter. (If you are entering the voltage value, allow time for the DVM to stabilize.) You must first select a calibration level (CAL:VOLT:LEV) for the value being entered. Two successive values (one for each end of the calibration range) must be selected and entered. The Agilent SAS then computes new voltage calibration constants. These constants are not stored in nonvolatile memory until saved with the CAL:SAVE command.

Command Syntax	CALibrate:VOLTage[:DATA] <NRf>
Parameters	(See applicable Output Ratings in appendix A)
Default Suffix	A
Examples	CAL: VOLT 322 . 5 MV CAL: VOLT: DATA 3 . 225
Related Commands	CAL:SAVE CAL:STAT

CAL:VOLT:LEV

This command sets the Agilent SAS to a calibration point that is then entered with CAL:VOLT[:DATA]. During calibration, two points must be entered and the low-end point (MIN) must be selected and entered first.

Command Syntax	CALibrate:VOLTage:DATA {MIN MAX}
Parameters	{ <CRD > MINimum MAXimum }
Examples	CAL: VOLT: LEV MIN CAL: VOLT: LEV MAX
Related Commands	CAL:VOLT[:DATA] CAL:STAT

CAL:VOLT:PROT

This command calibrates the Agilent SAS overvoltage protection (OV) circuit. The *output voltage must be in calibration* before this procedure is performed. Also, the Agilent SAS output must be enabled and operating in the constant voltage (CV) mode. If present, the optional relay accessory must either be disconnected or set to the off (open) state. The Agilent SAS automatically performs the calibration and stores the new OV constant in nonvolatile memory. CAL:VOLT:PROT is a sequential command that takes several seconds to complete.

Command Syntax:	CALibrate:VOLTage:PROTection
Parameters	(None)
Example	CAL: VOLT: PROT
Related Commands	CAL:STAT

Agilent BASIC Calibration Program

The following program can be run on any controller operating under Agilent BASIC. The assumed Agilent SAS address is 5 and calibration password is 4350. If required, change these parameters in the appropriate statements.

```
10      ! Agilent BASIC Calibration Program
20      !
30      DIM Resp$ [255],Err_msg$[255]
40      !
50 Volt_cal: !      Voltage DAC calibration
60      Err_found=0
70      PRINT TABXY(5,10),"CONNECT INSTRUMENTS AS SHOWN IN FIG. A-1(1). Then Press Continue"
80      PAUSE
90      CLEAR SCREEN
100     !
110     ! Assign Agilent SAS GPIB address
120     !
130     ASSIGN @Ps TO 705
140     !
150     ! Initialize Agilent SAS
160     !
170     OUTPUT @Ps;"*RST;OUTPUT ON"
180     !
190     ! Password is optional - only required if set to non-zero value
200     ! Default password is the four-digit model number
210     !
220     ! LINE 240 PASSWORD MUST BE EDITED FOR MODEL OTHER THAN E4350
230     !
240     OUTPUT @Ps;"CAL:STATE ON, 4350"
250     1
260     OUTPUT @Ps;"CAL:VOLTAGE:LEVEL MIN"
270     INPUT "ENTER VOLTAGE MEASUREMENT FROM EXTERNAL VOLTMETER",Volt_read
280     OUTPUT @Ps;"CAL:VOLTAGE ";Volt_read
290     OUTPUT @Ps;"CAL:VOLTAGE:LEVEL MAX"
300     INPUT "ENTER VOLTAGE MEASUREMENT FROM EXTERNAL VOLTMETER",Volt_read
310     OUTPUT @Ps;"CAL:VOLTAGE ";Volt_read
320     !
330     ! Calibrate overvoltage protection circuit
340     !
350     OUTPUT @Ps;"CAL:VOLTAGE:PROTECTION"
360     !
370     GOSUB Save_cal
380     IF Err_found THEN
390         INPUT "ERRORS have occurred, REPEAT VOLTAGE CALIBRATION ( Y OR N )?",Resp$
400         IF TRIM$(UPC$(Resp$[1,1] ) )="Y" THEN GOTO Volt_cal
410     END IF
420     IF Err_found THEN
430         PRINT "VOLTAGE CALIBRATION NOT SAVED"
440     ELSE
450         PRINT "VOLTAGE CALIBRATION COMPLETE"
460     END IF
470     !
480 Current_cal: !      Imon DAC and Current DAC calibration
490     Err_found=0
500     PRINT TABXY(5,10),"CONNECT INSTRUMENTS AS SHOWN IN FIG. A-1(2). Then Press Continue"
510     PAUSE
520     CLEAR SCREEN
530     !
```

Figure A-2. Agilent BASIC Calibration Program

```

540 Password is optional - only required if set to non-zero value
550 Default password is four-digit model number
560 !
570 OUTPUT @Ps;"CAL:STATE ON, 4350"
580 OUTPUT @Ps;"VOLT:LEV 2"
590 ! Refer to Table A-1 for correct shunt value for model being calibrated
600 !
610 INPUT "ENTER VALUE OF CURRENT SHUNT BEING USED",Shunt_val
620 OUTPUT @Ps;"CAL:CURRENT:LEVEL MIN"
630 INPUT "ENTER VOLTAGE MEASUREMENT FROM EXTERNAL VOLTMETER",Volt_read
640 Current=Volt_read/Shunt_val
650 OUTPUT @Ps;"CAL:CURRENT ";Current
660 OUTPUT @Ps;"CAL:CURRENT:LEVEL MAX"
670 INPUT "ENTER VOLTAGE MEASUREMENT FROM EXTERNAL VOLTMETER",Volt_read
680 Current=Volt_read/Shunt_val
690 OUTPUT @Ps;"CAL:CURRENT ";Current
700 GOSUB Save_cal
710 IF Err_found THEN
720     INPUT "ERRORS have occurred, REPEAT CURRENT CALIBRATION ( Y OR N )?",Resp$
730     IF TRIM$(UPC$(Resp$[1,1]))="Y" THEN GOTO Volt_cal
740 END IF
750 IF Err_found THEN
760     PRINT "CURRENT CALIBRATION NOT SAVED"
770 ELSE
780     PRINT "CURRENT CALIBRATION COMPLETE"
790 END IF
800 STOP
810 Save_cal: ! SAVE CALIBRATION
820 REPEAT
830     OUTPUT @Ps;"SYSTEM:ERROR?"
840     ENTER @Ps;Err_num,Err_msg$
850     IF Err_num<>0 THEN
860         PRINT "ERROR: ";Err_msg$
870         Err_found=1
880     END IF
890 UNTIL Err_num=0
900 IF NOT Err_found THEN
910     INPUT "SAVE CALIBRATION CONSTANTS ( Y OR N )?",Resp$
920     IF TRIM$(UPC$(Resp$[1,1]))="Y" THEN
930         OUTPUT @Ps;"CAL:SAVE"
940     END IF
950 END IF
960 OUTPUT @Ps;"CAL:STATE OFF"
970 RETURN
980 END

```

Figure A-2. Agilent BASIC Calibration Program (continued)

Digital Port Functions

Digital Connector

A 4-pin connector and a quick-disconnect mating plug are provided for digital input and output signals (see Figure C-1 for wiring connections and appendix A for electrical characteristics). This digital port can be configured to provide either Fault/Inhibit or Digital I/O functions.

Note Consistent with good engineering practice, twist and shield all signal wires to and from the digital connector.

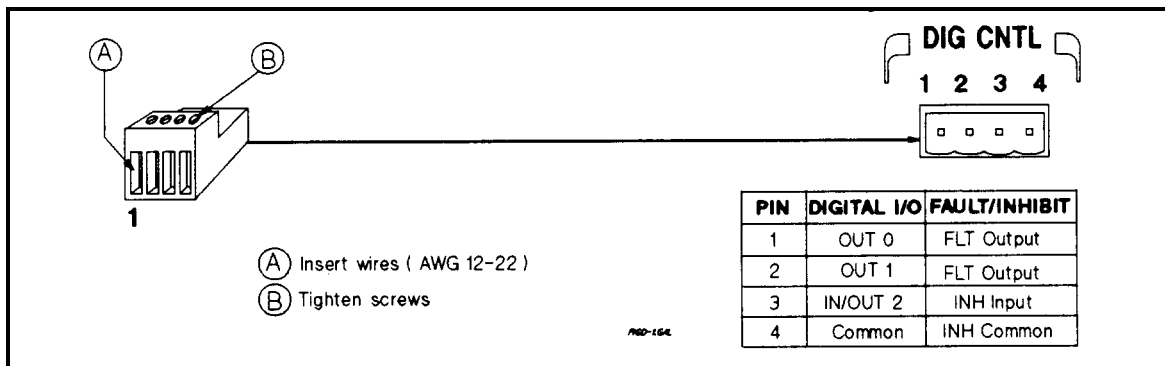

Figure C-1. Digital Port Connector

Fault/Inhibit Operation

As shipped from the factory, the digital port is configured to provide a fault indicator (FLT) output and a remote (INH) input. Unplug the mating plug to make the connections. After you have finished making all connections, plug the wired plug back into the connector.

FLT Output (pins 1 and 2) Used to indicate that a fault has occurred in power supply. Pins 1 and 2 are the open collector output of an optocoupler, with pin 1 the collector and pin 2 the emitter. When a fault has occurred, pin 1 is driven low with respect to pin 2 (negative-true).

INH Input (pin 3) Used to shut down the power supply output. Pin 3 is a high impedance input. The supply shuts down when this input is driven low (negative-true). This can be done by shorting pin 3 to pin 4.

INH Common (pin 4) Provides the common connection for the INH input.

Three examples are provided to show how to use the FLT/INH circuits of your power supply. Use twisted wire connections to reduce or prevent EM in all cases. If shielded wire is used, connect only one end of the shield to the chassis signal ground binding post to prevent ground loops.

In Figure C-2, the INH input is connected to a switch that shorts pin 3 to pin 4 whenever it is necessary to externally disable the output of the supply. This will activate the remote inhibit (RI) fault protection circuit, causing the front panel **Prot** annunciator to come on. It also sets the RI event bit in the supply's Questionable Status Event register (see chapter 8 - Status Reporting). To re-enable the supply after it has been disabled by the INH input, first open the connection between pins 3 and 4. Then clear the protection circuit either from the front panel (see chapter 5) or over the GPIB (see chapter 8).

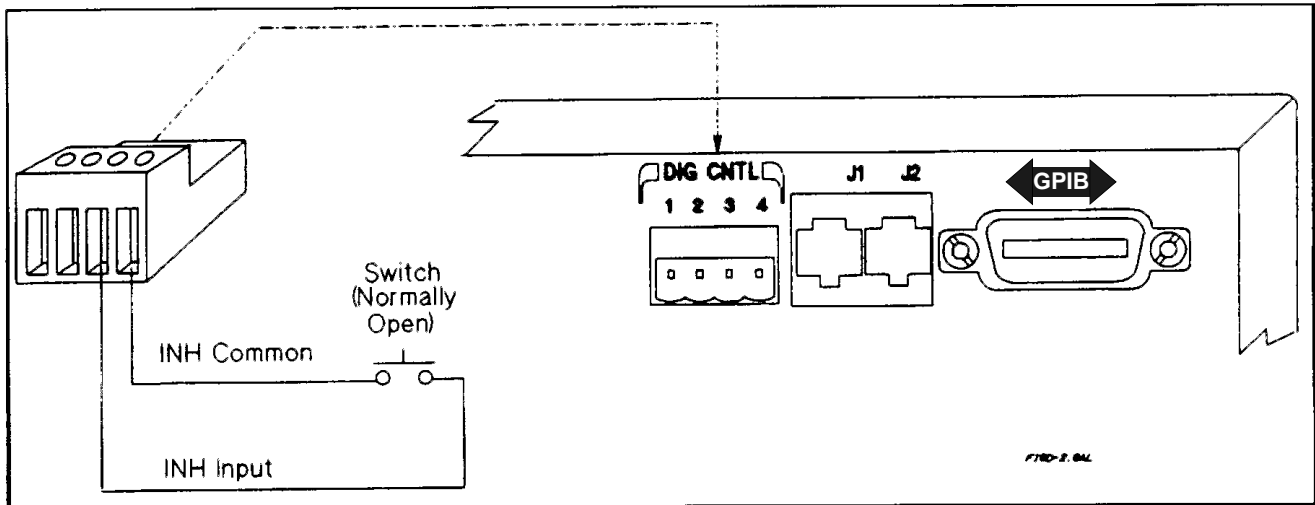

Figure C-2. Example of Inhibit Input

In Figure C-3A, the FLT output is connected to a relay driver circuit that energizes a relay whenever a fault condition occurs in the power supply. The relay can be used to physically disconnect the output of the power supply from the load. The FLT output is generated by the logical ORing of the power supply's Operation, Questionable, and Event status summary bits (see chapter 8). You can cause one or more events to activate the FLT output by enabling the appropriate events in these status registers. The fault condition is cleared by first removing the cause of the fault and then reading the appropriate status event register(s).

In Figure C-3B, the FLT output of one supply is connected to the INH input of another supply. Although only two supplies are shown, it is possible to chain other supplies with this arrangement. A fault condition in any one of the power supplies will disable all of them without intervention either by the controller or external circuitry. The controller can be made aware of the fault via a service request (SRQ) generated by the Questionable Status summary bit (see chapter 8).

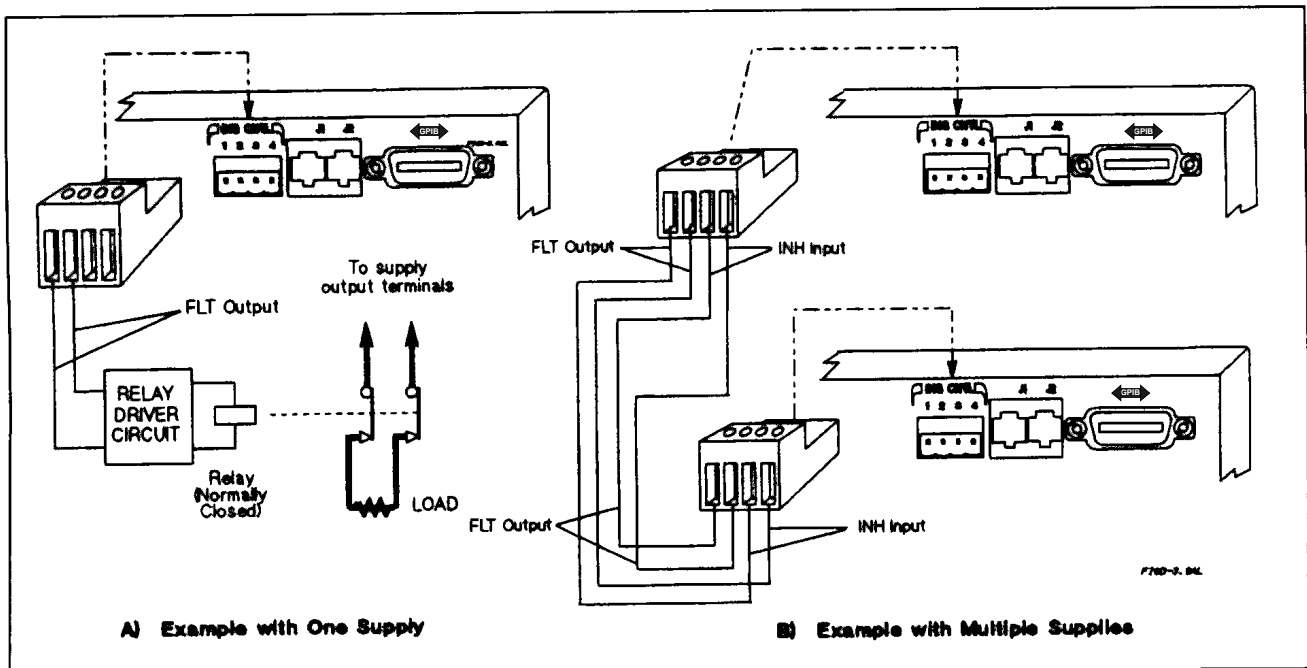

Figure C-3. Examples of FLT Outputs

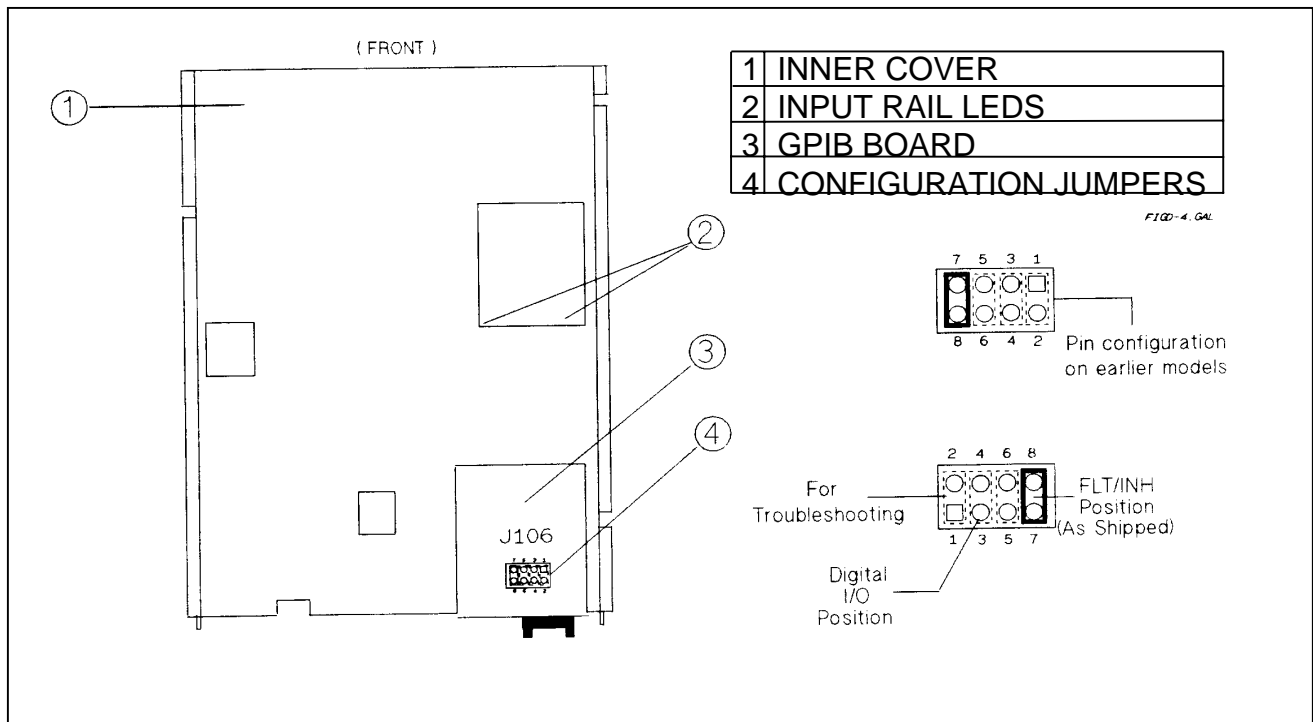

Figure C-4. Digital Port Configuration Jumper

Changing The Port Configuration

As shipped from the factory, the digital port is configured for FLT/INH operation. You can change the configuration of the port to operate as a general-purpose digital input/output port to control your custom circuitry as shown in Figure C-4. To change the port configuration, you must move a jumper on the GPIB board.

WARNING

Shock Hazard. Hazardous voltage can remain inside the power supply even after it has been turned off. This procedure should only be done by qualified electronics service personnel.

Proceed as follows:

1. Turn off the power supply and disconnect the power cord from the power source.
2. Remove the four screws that secure the two carrying straps and outer cover.
3. Spread the bottom rear of the cover and pull it back to disengage it from the front panel.
4. Slide the outer cover back to expose the top of the GPIB board.
5. Refer to Figure C-4 and use needle-nose pliers to move the jumper to the Digital I/O position.
6. Replace the outer cover, and secure the carrying straps.
7. Make the necessary wire connections to the digital connector.

Digital I/O Operation

The digital port can be configured (see Figure C-4) to provide a digital input/output to be used with custom digital interface circuits or relay circuits. Some examples are shown Figure C-5. See Figure C-1 for the pin assignments of the mating plug and appendix A for the electrical characteristics of the port. See DIG:DATA[:VAL] in chapter 7 - Language Dictionary for information on programming the port. The digital port pins are as follows:

- OUT 0** (pin 1) This port can only be used as an open-collector output. It is assigned a bit weight of 1.
- OUT 1** (pin 2) This port can only be used as an open-collector output. It is assigned a bit weight of 2.
- IN/OUT 2** (pin 3) This port can be programmed to be either a high impedance input or an open-collector output.
- Common** (pin 4) This pin is the common connection for the Digital I/O ports.

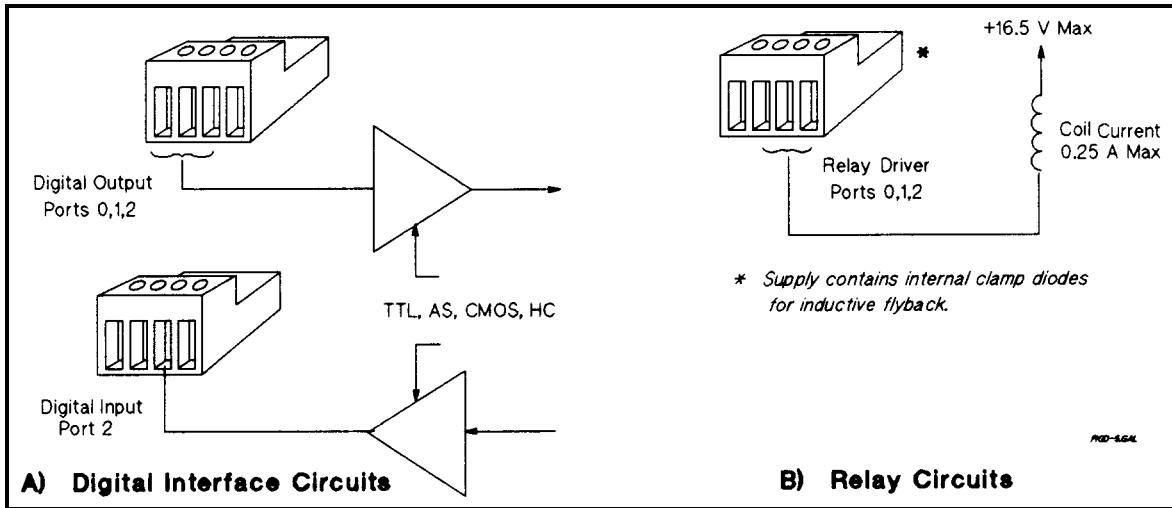

Figure C-5. Digital I/O Port Applications

Error Messages

Hardware Error Messages

Front panel error messages resulting from selftest errors or runtime failures are described in chapter 3 - Turn-On Checkout.

Calibration Error Messages

Front panel error messages resulting from calibration errors are described in appendix B.

System Error Messages

System error messages are obtained remotely with the **SYST:ERR?** query or by pressing the front panel **Error** key. The error number is the value placed in the error queue. **SYST:ERR?** returns the error number into a variable and combines the number and the error message into a string. Table D-1 lists the system errors that are associated with SCPI syntax errors and with interface problems. Information inside the brackets is not part of the standard error message, but is included for clarification. When system errors occur, the Standard Event Status register (see chapter 8) records them as follows:

Standard Event Status Register Error Bits

Bit Set	Error Code	Error Type	Bit Set	Error Code	Error Type
5	-100 thru -199	Command	3	-300 thru -399	Device-dependent
4	-200 thru -299	Execution	2	-400 thru -499	Query

Table D-1. Summary of System Error Messages

Error Number	Error String [Description/Explanation/Examples]
-100	Command error [generic command error]
-101	Invalid character
-102	Syntax error [unrecognized command or data type]
-103	Invalid separator [illegal character encountered in place of separator]
-104	Data type error [e.g., "numeric or string expected, got block data"]
-105	GET not allowed [<GET> inside a program message]
-108	Parameter not allowed [too many parameters]
-109	Missing parameter [too few parameters]
-112	Program mnemonic too long [maximum 12 characters]
-113	Undefined header [syntactical correct but not defined for this device]
-121	Invalid character in number [e.g. alpha in decimal data, etc.]
-123	Exponent too large [numeric overflow; exponent magnitude >32000]
-124	Too many digits [number too long; more than 255 digits received]
-128	Numeric data not allowed [numeric data not accepted where positioned]
-131	Invalid suffix [unrecognized suffix, or suffix not appropriate]
-138	Suffix not allowed [numeric element does not allow suffixes]

Table D-1. Summary of System Error Messages (continued)

Error Number	Error String [Description/Explanation/Examples]
-141	Invalid character data [bad character, or unrecognized]
-144	Character data too long [maximum length is 12 characters]
-148	Character data not allowed [character data not accepted where positioned]
-150	String data error [generic string error]
-151	Invalid string data [e.g., END received before close quote]
-158	String data not allowed [string data not accepted where positioned]
-160	Block data error [generic data block error]
-161	Invalid block data [e.g., END received before length satisfied]
-168	Block data not allowed [block data not accepted where positioned]
-220	Parameter error
-221	Settings conflict [uncoupled parameters]
-222	Data out of range [e.g., outside the range of this device]
-223	Too much data [out of memory; block, string, or expression too long]
-240	Hardware error [device-dependent]
-241	Hardware missing [device-dependent]
-310	System error [device-dependent]
-313	Calibration memory lost [out of calibration due to memory failure]
-330	Self-test failed [more specific data after “;”]
-350	Queue overflow [errors lost due to too many errors in queue]
-400	Query error [generic query error]
-410	Query INTERRUPTED [query followed by DAB or GET before response complete]
-420	Query UNTERMINATED [addressed to talk, incomplete programming message received]
-430	Query DEADLOCKED [too many queries in command string]
-440	Query UNTERMINATED [query received after query for indefinite response]
0	No error
1	CAL jumper prevents calibration
2	CAL passcode is incorrect
3	CAL not enabled
4	Computed readback CAL constants are incorrect
5	Computed programming CAL constants are incorrect
6	Wrong sequence of calibration commands
7	CV or CC status is incorrect for this command
100	Table data not monotonic
101	Tables not same length [# of voltage points different from # of current points]
102	Table full
103	No table selected
104	Table in use
105	Too many tables
106	Empty table
107	Table has points exceeding maximum output power

Index

A

<AARD>, 53, 63, 64

air clearance, 20

air fan, 23

analog port

characteristics, 29

connector configuration, 29

signals, 29

programming, 29

annunciators, 42

Addr, 23, 42

CC, 32, 42

CV, 24, 42

Cal, 42, 109

Dis, 23, 27, 42

Err, 18, 42

OCP, 26, 42, 47

Prot, 25, 27, 42, 46

Rmt, 42

Shift, 25, 42

SRQ, 42

Unr, 42, 48

autoparallel

cautions, 36

connections, 35, 36

examples, 54, 55

operation, 36

B

blank display, 27

C

CAL bit (see status bit)

calibration, 108

password, 109

procedure, 108

disabling, 109

enabling, 109

equipment required, 106

jumper, 110, 111

over GPIB, 111

program for, 114

SCPI commands for, 111

setup, 105

shunt resistor, 105

calibrating

current, 110

OVP, 110

voltage, 109

capacitive load, 30

CC mode, 36, 43, 46, 47, 56, 110

checkout, 23

output current, 25

output voltage, 23

power-on, 23

preliminary, 23

common commands

*CLS, 62, 63, 67, 80, 82, 87, 89, 90

*ESE, 56, 62, 63, 64, 65, 67, 89, 90, 91

*ESR?, 56, 62, 63, 89

*IDN?, 50, 62, 63

*OPC, 62, 63, 64, 68, 92

*OPC?, 62, 64, 68, 92

*PSC, 62, 63, 65, 66, 67, 89, 91

*RCL, 27, 51, 55, 62, 65, 66, 67, 74, 75, 78, 79, 84

*RST, 15, 24, 27, 43, 44, 47, 50, 54, 55, 62, 65, 66, 67, 71, 72, 84, 90

*SAV, 47, 55, 62, 65, 66, 67, 74, 75, 78, 79

*SRE, 50, 56, 62, 65, 67, 90, 91, 92

*STB?, 62, 63, 67, 68, 89, 90

*TRG, 51, 55, 62, 64, 68, 84, 85

*TST?, 62, 68

*WAI, 62, 64, 68, 92

Common P, 29

connections (see GPIB connections)

connector

analog port, 118

digital port, 118, 119

<CRD>, 53

Current control, 31, 42, 47

current monitor, 29, 105, 107

current monitoring resistor, 105

CV bit (see status bit)

CV mode, 43, 47, 58-60

D

data

boolean, 53, 66, 71, 74, 83

character, 53

multiplier, 53

numerical, 53

suffix, 53

device clear, 50, 64, 68, 93

DDE bit (see status bit) default state (see *RST state)

DFI, 35, 92, 93, 98

digital port, 117

applications, 120

connections, 117

configuration jumper, 119

pin configuration, 120

electrical characteristics, 97

E

electrostatic discharge 20

equations, 103

error messages

- calibration, 111, 122
- hardware, 121
- runtime, 28, 121
- selftest, 28, 121
- system, 121

error queue, 83, 90

exhaust fan, 19, 20, 23

external current control, 37

ESB bit (see status bit)

ESD pulse, 20

EXE bit (see status bit)

F

factory-default state (see *RST state)

Fixed

- mode, 17
- restrictions, 18

FLT output, 30, 92, 98, 117

front panel, 17, 18, 41, 42

front panel annunciators (see "annunciators")

front panel data ENTRY keys, 42

front panel keys

, 25, 43, 45, 47

Address, 27, 42, 43

Cal Save, 109, 110

Clear Entry, 43

Current, 26, 43, 45

↓Current, 26, 42, 45

↑Current, 26, 42, 45

Enter, 24, 43

Error, 42

Local, 42

OCP, 26, 33, 42, 43

Output on/off, 23, 43, 47

OV, 25, 27, 42, 43, 46

Protect, 25, 43, 45

Prot Clear, 25, 43, 46

Recall, 27, 42, 44, 47

Save, 27, 42, 47

 shift, 24, 41, 42

Voltage, 24, 43, 44

↓Voltage, 24, 43, 44

↑Voltage, 24, 43, 44

front panel LCD, 41, 42

front panel RPG controls, 42

- Current**, 26, 43, 45

- Voltage**, 24, 25, 43, 44

fuse, 20

G

ground

- chassis, 30, 36

- earth, 13, 30

- signal, 30

<GET> command, 68, 84

H

handles, rack, 13

hardware, 14

header, (see SCPI header)

Agilent BASIC, 57

DOS driver, 57

GPIB

- address, 27, 37, 38

- cables, 13

- capabilities, 98

- connections 37, 38

- program errors, 121

I

Imp, 16, 54, 103

impedance

- analog input, 37

- load (see inductive load)

- output, 15, 35, 47, 99

implied

- colon, 50, 51

- decimal point, 52

- header (see header, optional)

- message terminator, 52

inductive load, 31, 32

INH input, 30, 93, 117, 118

initial conditions (see turn-on conditions)

interrupt, 56, 90

Isc, 16, 54, 104

isolation (see output isolation)

J

jumper

- calibration, 108

- digital port configuration, 119

- line voltage selection, 21

K

keyword (see header)

kit

- rack-mounting, 13

L

LED (see front panel LEDs)
line cord, 19, 20
line fuse (see fuse)
linked connections, 37
local voltage sensing, 31
load
 capacitive (see capacitive load)
 inductive (see inductive load)
load wire, 29

M

maximum power, 16, 17
measurement subsystem, 72
memory (table) subsystem, 73
message, error (see error messages)
meter mode, 24
monitor, current (see current monitor)

N

National Instruments DOS driver, 57
nonvolatile memory, 14, 17, 65, 69, 73, 76, 97
<NR1>, 53
<NR2>, 53
<NR3>, 53
<Nrf>, 53
<Nrf+>, 53

O

OC, 33, 43, 74, 76
OC bit (see status bit)
OCP operation, 46, 47
OCP, 17, 25, 32, 46, 47, 76
OCP key (see front panel keys)
offsets, 18
operating features, 14
OPC bit (see status bit)
OPER bit (see status bit)
OT, 43, 74, 82, 91
OT bit (see status bit)
OUT OF RANGE, 15, 44
output characteristic, 15
output isolation, 30, 97
output impedance (see impedance, output)
output queue, 62, 90
OV, 25, 43, 46
OV bit (see status bit)
OV OC, 17
overcurrent protection (see OCP)
overlapped commands, 64
overvoltage protection (see OVP)
OVP operation, 45, 46
OVP, 25, 31, 32, 35, 45, 46, 75, 79

P

packaging material, 19
parallel commands (see overlapped commands)
parallel operation, 34
peak power tracker, 102
performance test, 105
Pmp, 16, 103
PON bit (see status bit)
power cord (see line cord)
power-on
 conditions (see turn-on conditions)
 checkout, 23
 status, 90
power options, 13
power receptacle, 20
power source, 13, 20
primary address (see GPIB address)
programming
 accuracy, 95
 analog, 37
 examples, 56
 parameters, 71
 pending operations, 55, 64, 68, 75, 85, 92
 resolution, 96
program message (see SCPI, command message)
PSC bit (see status bit)
PWR ON, 48

Q

query, 51, 56, 61, 62
QUES bit (see status bit)
QYE bit (see status bit)

R

reading registers, 33, 56, 89, 90
real-time status, 80, 82, 87, 90
recalled parameters, 65, 66
recalling states, 14, 27, 41, 48, 55, 65, 66
register commands
 status byte, 68, 89
 status operation, 76, 87
 status preset, 81
 status questionable, 82, 89
 standard event, 63, 64, 89
regulation
 series, 104
 shunt, 104
remote inhibit (see RI)
remote voltage sensing, 16, 31
 and output noise, 32
 and output rating, 32
 and output stability, 32
 switch, 30, 31
reset state (see *RST state)

response message, 51
resistor, current monitoring, 105
RI
 description, 93, 98, 117
 connector, 30, 117, 118
root specifier, 52
RQS bit (see status bit)
*RST state, 66, 90
RST POWER-ON, 48

S

safety class, 13
safety compliance, 98
safety cover, ac input, 14
safety warning, 13, 20, 21, 29, 30, 36, 65, 105
saved parameters, 66
saving states, 27, 47, 55, 66
SCPI
 active header path, 51
 command tree, 50, 69, 70
 common commands, 50, 62
 completed commands, 92
 conventions, 49
 coupled commands, 51
 definition, 49
 message structure, 52
 message terminator, 52
 message unit, 52
 message unit separator, 52
 query indicator, 52
 related commands, 61
 root specifier, 52
 version, 84
SCPI header
 conventions, 52
 long form, 52
 optional, 49, 51
 path, 51
 separator, 52
 short form, 52
serial poll, 67, 89
series
 connections, 36
 operation, 36
 regulation, 104
service request (see SRQ)
SETUP.BAS, 60
<SRD>, 53, 83
SRQ, 42, 56, 65, 67, 90, 91
SCPI subsystem command
 ABOR, 84
 CURR, 75
 CURR:MODE, 76
 CURR:PROT, 76

 CURR:PROT:STAT, 76
 CURR:SAS:ISC, 77
 CURR:SAS:IMP, 77
 CURR:TABL:NAME, 77
 CURR:TABL:OFFS, 77
 CURR:TRIG, 75
 DIG:DATA, 77
 DISP, 71
 DISP:MODE, 71
 DISP:TEXT, 72
 MEAS:CURR?, 72
 MEAS:VOLT?, 72
 MEM:COPY:TABL, 73
 MEM:DEL:ALL, 73
 MEM:TABL:CAT?, 74
 MEM:TABL:CURR, 73
 MEM:TABL:CURR:POIN?, 74
 MEM:TABL:SEL, 73
 MEM:TABL:VOLT, 73
 MEM:TABL:VOLT:POIN?, 74
 INIT, 84
 INIT:CONT, 84
 OUTP, 74
 OUTP:PROT:CLE, 74
 OUTP:PROT:DEL, 75
 STAT:OPER?, 80
 STAT:OPER:COND?, 80
 STAT:OPER:ENAB, 81
 STAT:OPER:NTR, 81
 STAT:OPER:PTR, 81
 STAT:PRES, 81
 STAT:QUES?, 82
 STAT:QUES:COND?, 82
 STAT:QUES:ENAB, 82
 STAT:QUES:NTR, 83
 STAT:QUES:PTR, 83
 SYST:ERR?, 83
 SYST:VERS?, 84
 TRIG, 85
 TRIG:SOUR, 85
 VOLT, 78
 VOLT:TRIG, 78
 VOLT:PROT, 79
 VOLT:SAS:VOC, 79
 VOLT:SAS:VMP, 79
 VOLT:TABL:OFFS, 80
shunt regulation, 104
simulator
 mode, 16
 restrictions, 16
 equations, 103
stand-alone connections, 37
status
 operation, 80, 87
 questionable, 82, 89

- standard event, 56, 62, 80, 87, 89
- status bit
 - CAL, 76, 88
 - CC, 76, 88
 - CME, 63, 88
 - CV, 76, 88
 - DDE, 63, 88
 - ESB, 63, 68, 88, 91
 - EXE, 63, 88
 - MAV, 63, 68, 88, 90
 - MSS, 67, 88, 90
 - OC, 71, 74, 77, 88, 92
 - OPC, 63, 88, 93
 - OPER, 68, 88, 92
 - OT, 74, 77, 88, 9
 - OV, 77, 83, 88
 - PON, 63, 88, 91, 108
 - PSC, 64, 65, 68, 89, 91
 - QUES, 68, 88
 - QYE, 63, 77, 88
 - RI, 77, 88, 93
 - RQS, 88, 92
 - UNR, 77, 88
 - WTG, 70, 77, 80, 88
- specifications, 95
- supplemental characteristics, 96
- status, 87
- subsystem commands, 69
- switch, sense, 30, 31
- support rails, 13, 20

T

table

- mode, 15
- restrictions, 15
- memory, 17, 97
- offsets, 18
- temperature characteristics, 95, 96
- temperature, environment, 20, 30
- tree diagram, 50, 62
- trigger
 - continuous, 84
 - immediate, 69, 84
 - initiating, 84
 - source, 85
- turn-on conditions, 47, 49, 90

U

- units (see data, suffix)
- UNR bit (see status bit)
- unregulated operation, 20, 32, 42, 47

V

- value coupling, 51
- verification test, 106
- Vmp, 16, 54, 103
- Voc, 16, 54, 103
- voltage sensing (see local or remote voltage sensing)

W

- wait state, 68
- warning (see safety warning)
- wire size, 29
- WTG bit (see status bit)

Agilent Sales and Support Offices

For more information, call your local Agilent sales office listed in your telephone directory or an Agilent regional office listed below for location of your nearest sales/support office.

United States of America:

Agilent Technologies Company
Test and Measurement Organization
5301 Stevens Creek Blvd
Bldg 51L-5C
Santa Clara, CA 95052-8059
(800) 452 4844

Asia Pacific:

Agilent Technologies Asia Pacific Ltd.
17-21/F Shell Tower, Time Square
1 Matheson Street, Causeway Bay,
Hong Kong
(852) 2599 7070

Australia/New Zealand:

Agilent Technologies Australia Ltd.
31-41 Joseph Street
Blackburn, Victoria 3130
Australia
131 347 ext. 2902

Canada:

Agilent Technologies Canada Ltd.
5150 Spectrum Way
Mississauga, Ontario L4W 5G1
(905) 206 4725

Europe:

Agilent Technologies
European Marketing Center
P.O. Box 999
1180 AZ Amstelveen
The Netherlands

Japan:

Yokogawa Agilent Technologies Ltd.
Measurement Assistance Center
9-1, Takakura-Cho, Hachioji-Shi,
Tokyo, 192, Japan
(81) 426 48 3860

Latin America:

Agilent Technologies
Latin American Region Headquarters
5200 Blue Lagoon Drive
9th Floor
Miami, Florida 33126
U.S.A.
(305) 267 4245/4220

Manual Updates

The following updates have been made to this manual since the print revision indicated on the title page.

3/01/00

All references to HP have been changed to Agilent.

All references to HP-IB have been changed to GPIB.

Information about installing *VXIplug&play* instrument drivers has been added to page 21.